

# QN95B

**\*Dimensions in millimeters (+ / - 0.1 mm)**

## QN95B 55"/65"/75"/85" Set Dimension

	QN95B 55"	QN95B 65"	QN95B 75"	QN95B 85"
SET(With stand) (W * H * D)	1228.0 * 777.3 * 298.4	1446.9 * 900.2 * 298.4	1670.6 * 1024.5 * 318.3	1894.2 * 1153.6 * 341.4
SET(With stand & With OC) (W * H * D)	1228.0 * 777.3 * 312.6	1446.9 * 900.2 * 312.6	1670.6 * 1024.5 * 332.5	1894.2 * 1153.6 * 355.6
SET(Without stand) (W * H1(H2) * D2(D1))	1228.0 * 707.3 * 17.4	1446.9 * 829.7 * 17.4	1670.6 * 958.4 * 17.8	1894.2 * 1084.4 * 17.8
* Front Opening Area (A * B * C)	1221.4 * 695.5 * 1405.5	1440.3 * 817.9 * 1656.3	1664.0 * 946.6 * 1914.4	1886.2 * 1071.9 * 2169.5
Wall Mount (a * b)	400 * 300	400 * 300	400 * 400	600 * 400
Packing Out (W * H * D)	1427 * 843 * 179	1625 * 947 * 195	1872 * 1144 * 196	2114 * 1260 * 220
Net Weight (With stand) Kg	24.2	30.4	41.3	54.4
Net Weight (Without stand) Kg	16.1	22.3	31.3	43.4
Gross Weight Kg	33.2	40.8	54.5	70.7

North America Box Dimension will be updated soon.

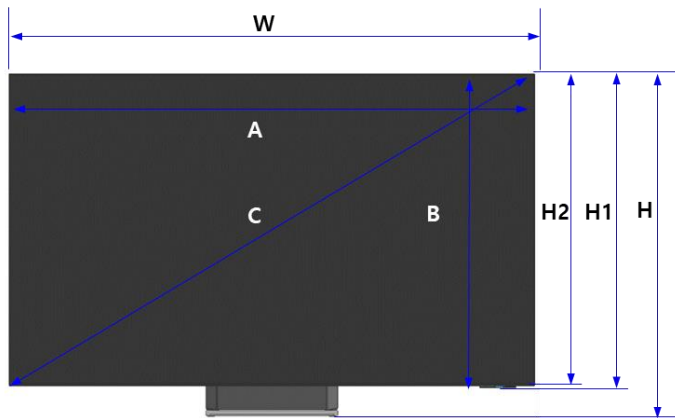
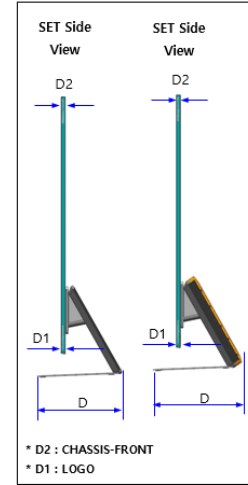

SET Front View \*Include Rubber-foot

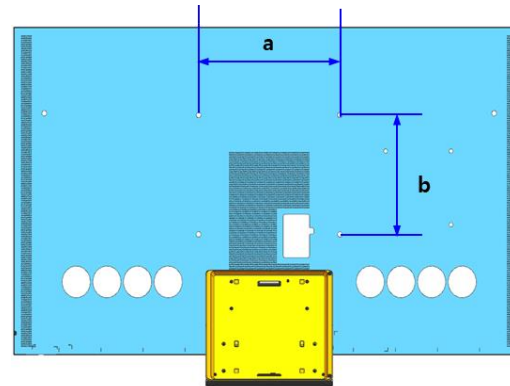

SET Rear View without OC

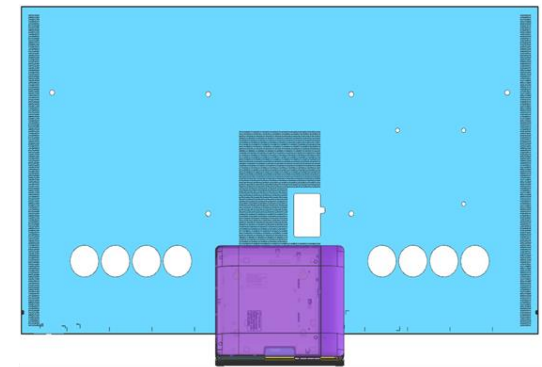

SET Rear View with OC

# QN95B

*\*Dimensions in millimeters (+ / - 0.1 mm)*

## QN95B Cover and Rear View Dimensions

		QN95B			
		55"	65"	75"	85"
<b>VESA WALL MOUNT(AXB)</b>		400 X 300	400 X 300	400 X 400	600 X 400
<b>C</b>		414.0	523.5	635.3	647.1
<b>D</b>		186.6	221.2	217.9	218.6
<b>E</b>		215.5	303.3	335.3	461.3
<b>Screw Depth</b>		5-6	5-6	5-6	5-6
<b>SLIM WALL MOUNT</b>	<b>H</b>	211.6	216.9	217.9	218.8
	<b>I</b>	86.8	86.9	87.9	88.6
<b>WALL MOUNT OC</b>	<b>J</b>		311.7	381.7	483.7
	<b>K</b>		185.0	185.0	185.0
	<b>L</b>		209.0	289.3	302.1
	<b>M</b>		185.0	185.0	185.0

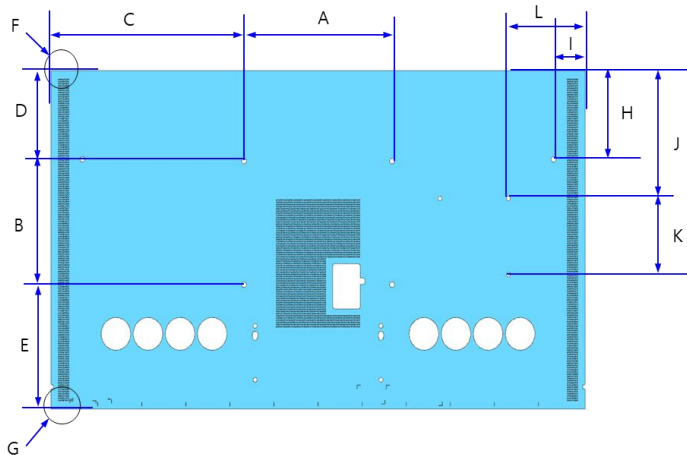

Detail "F"

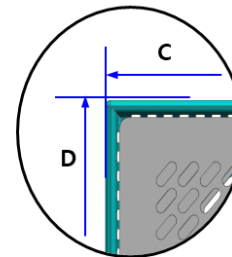

Detail "G"

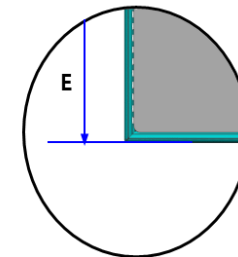

\* C,D Dimension based on outer-most dimension (Chassis-Front & Chassis-Rear)

# QN95B

*\*Dimensions in millimeters (+ / - 0.1 mm)*

**QN95B 55" Cover and Rear View Dimensions**

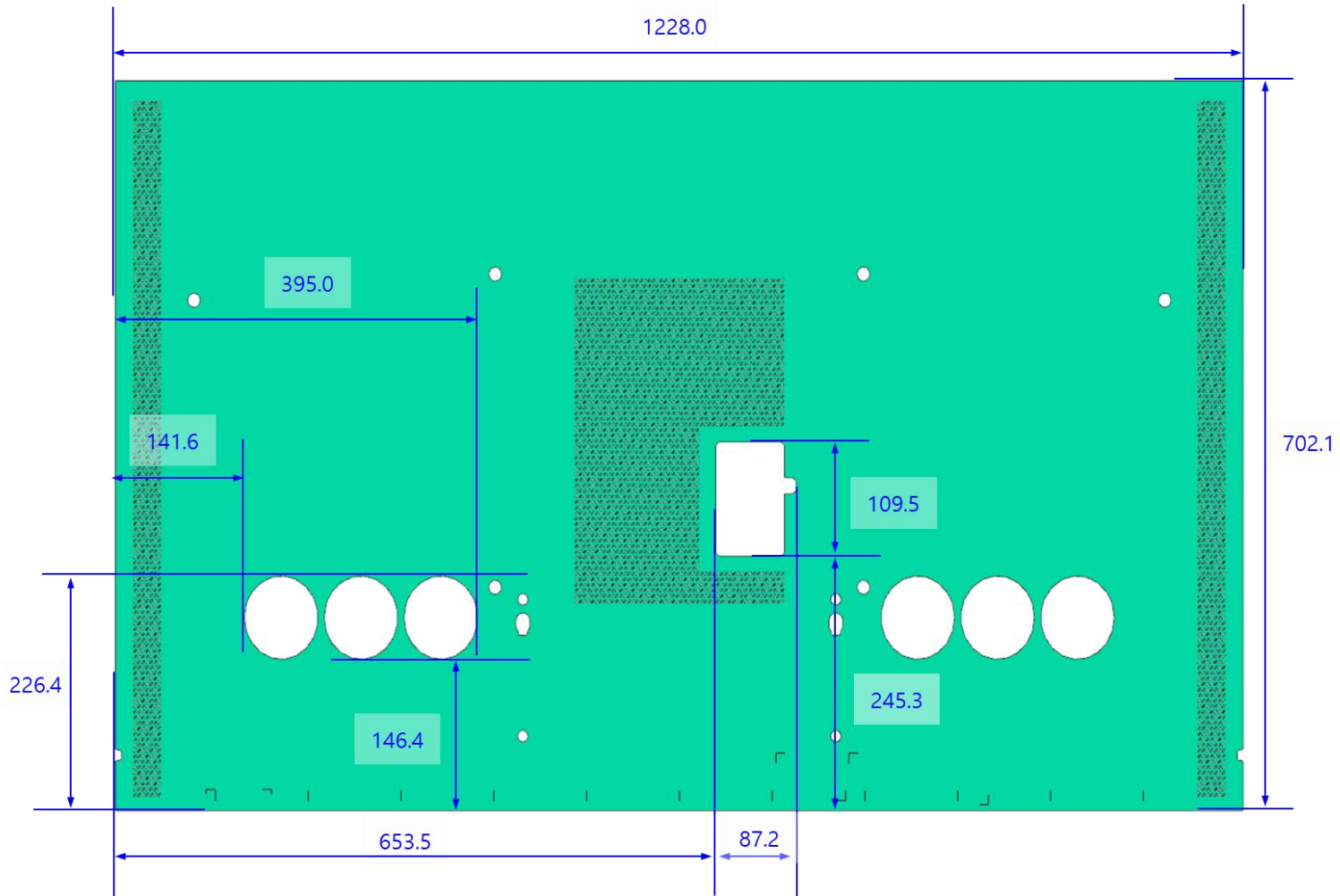

# QN95B

*\*Dimensions in millimeters (+ / - 0.1 mm)*

**QN95B 65" Cover and Rear View Dimensions**

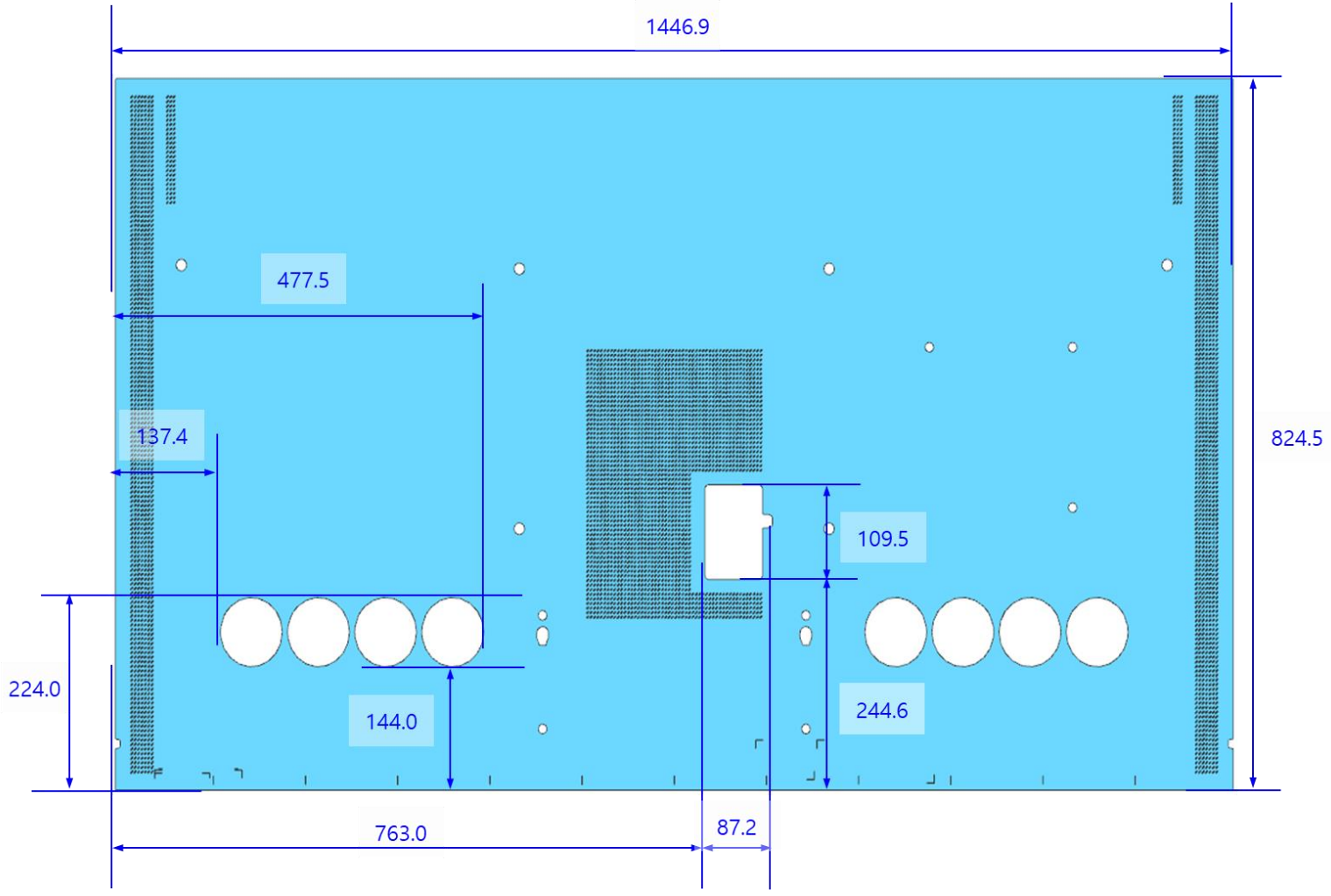

# QN95B

*\*Dimensions in millimeters (+ / - 0.1 mm)*

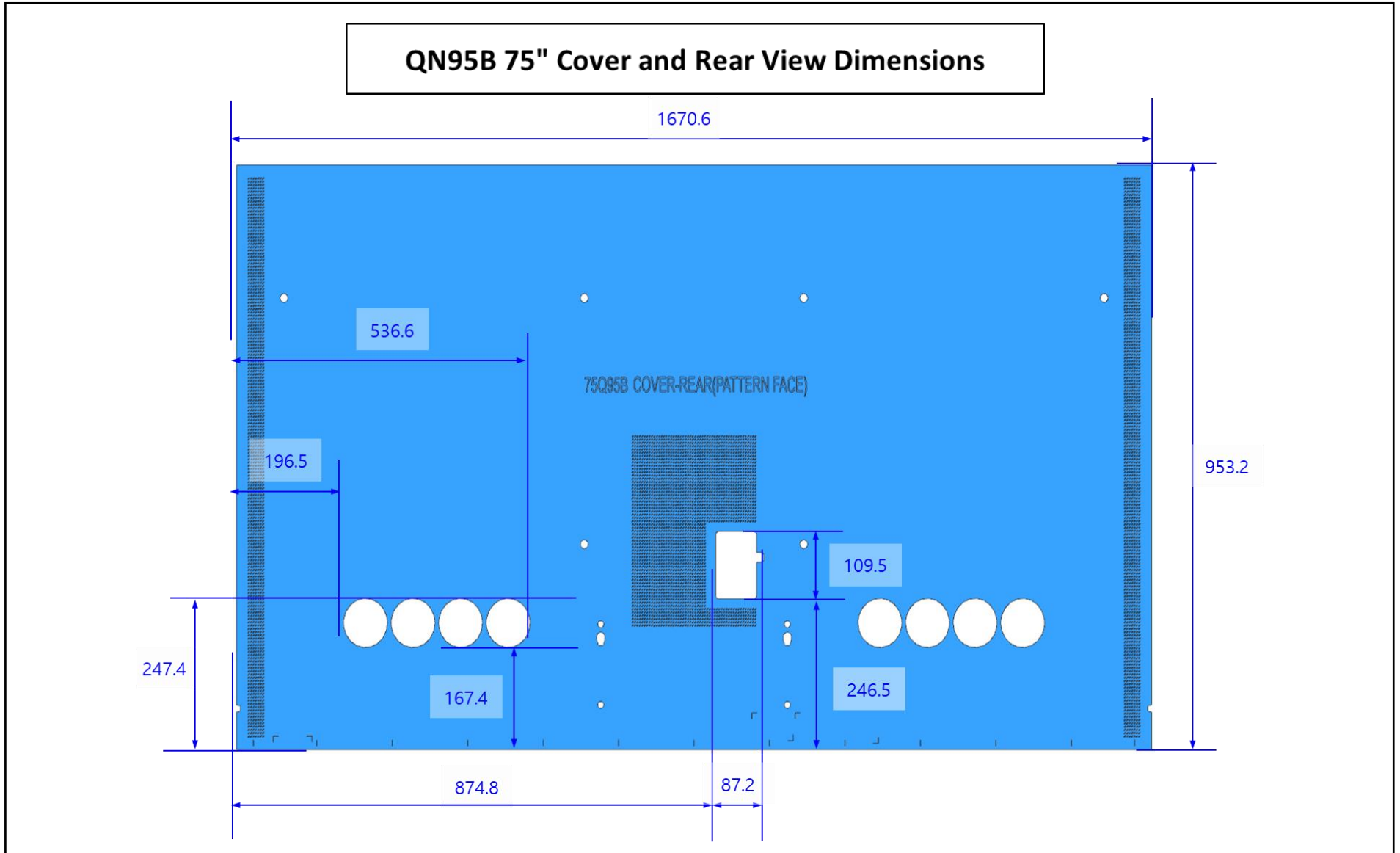

# QN95B

*\*Dimensions in millimeters (+ / - 0.1 mm)*

QN95B 85" Cover and Rear View Dimensions

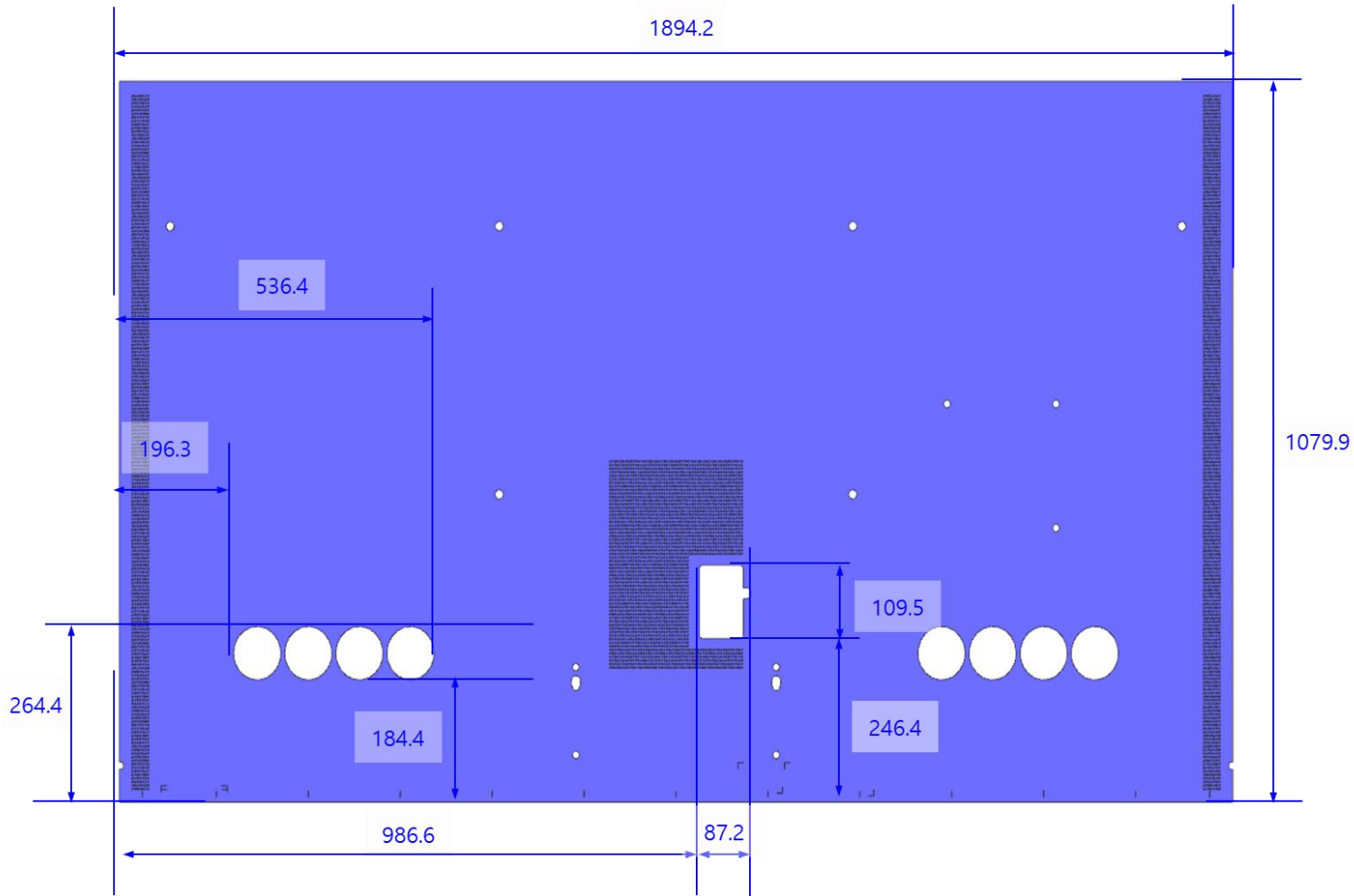

# QN95B

*\*Dimensions in millimeters (+ / - 0.1 mm)*

## QN95B 55" Cover and Rear Vent Area

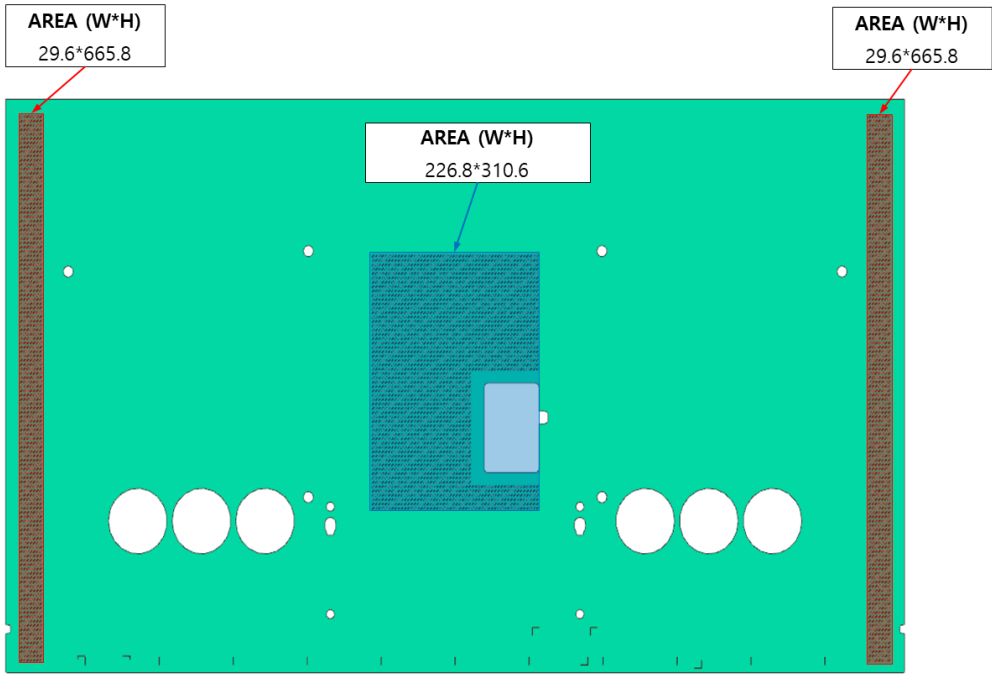

※ VENT Detailed Size (CENTER)

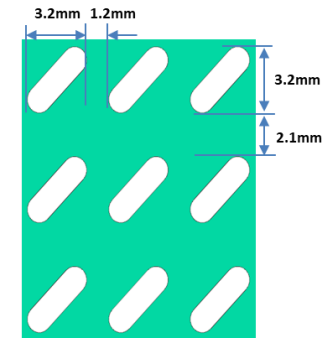

※ VENT Detailed Size (SIDE)

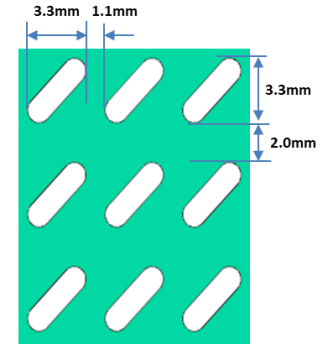

# QN95B

*\*Dimensions in millimeters (+ / - 0.1 mm)*

## QN95B 65" Cover and Rear Vent Area

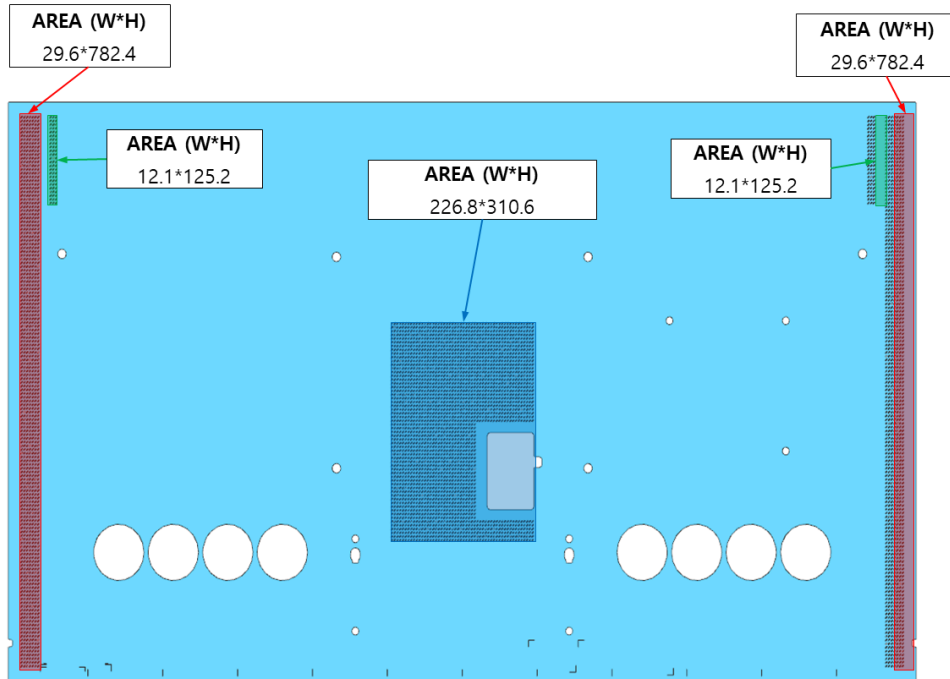

※ VENT Detailed Size (CENTER)

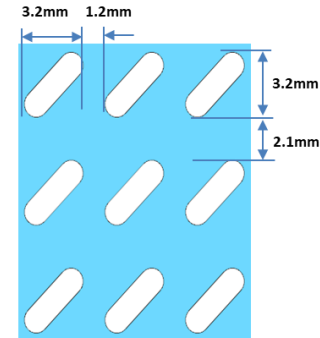

※ VENT Detailed Size (SIDE)

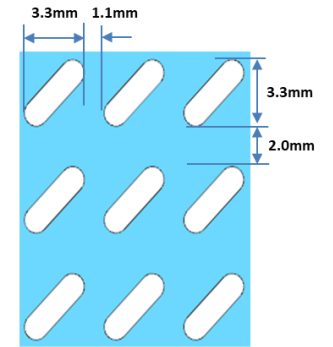

※ VENT Detailed Size (TOP)

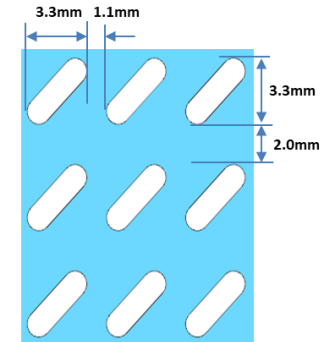



# QN95B

*\*Dimensions in millimeters (+ / - 0.1 mm)*

## QN95B 75" Cover and Rear Vent Area

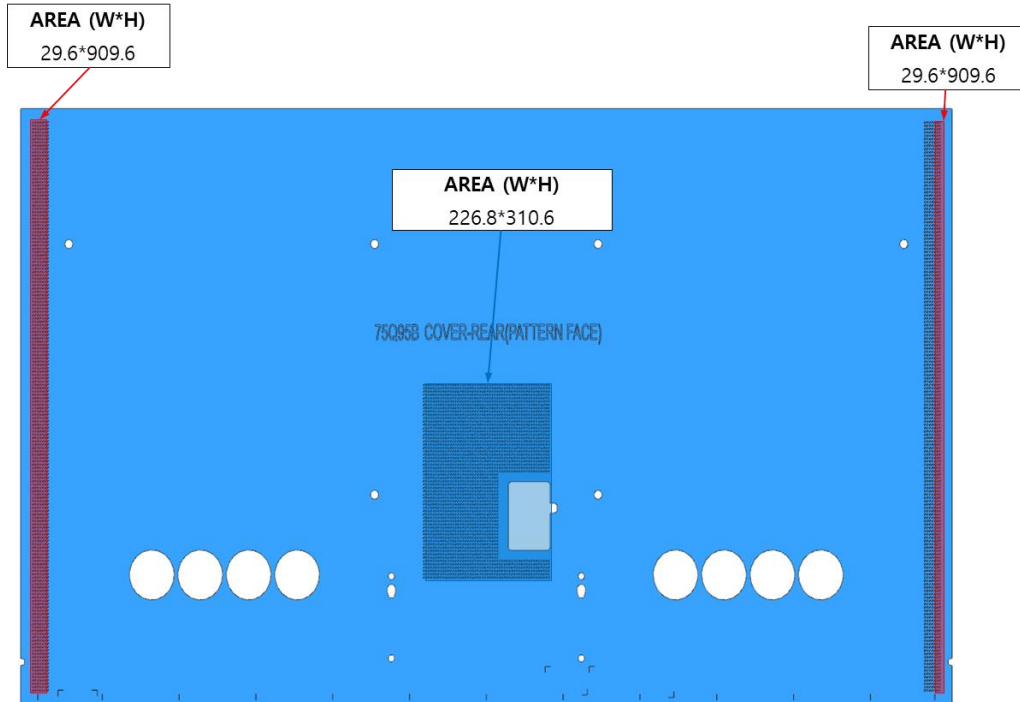

※ VENT Detailed Size (CENTER)

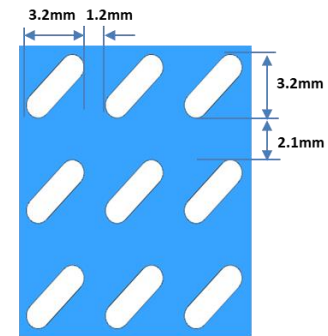

※ VENT Detailed Size (SIDE)

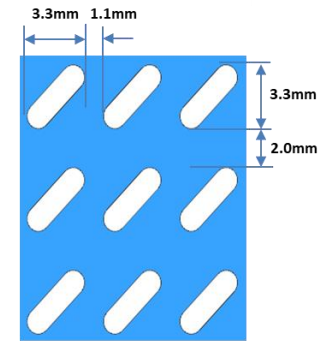

## QN95B 85" Cover and Rear Vent Area

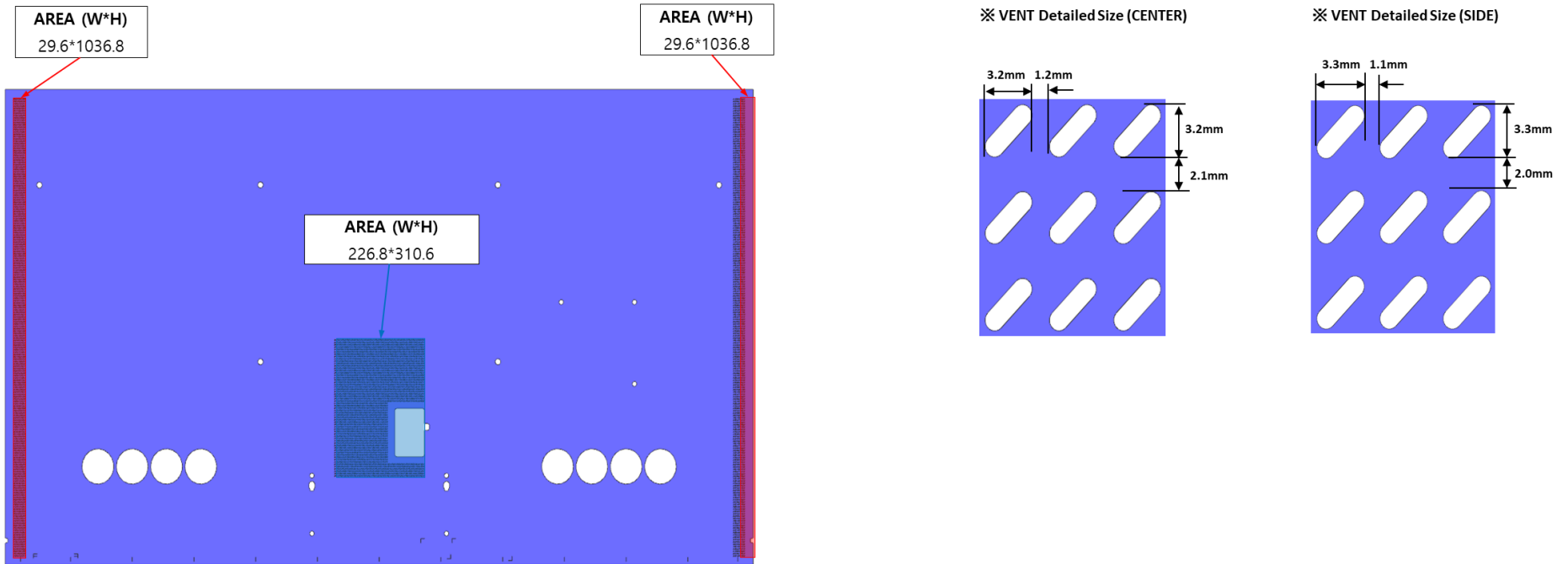

# QN95B

*\*Dimensions in millimeters (+ / - 0.1 mm)*

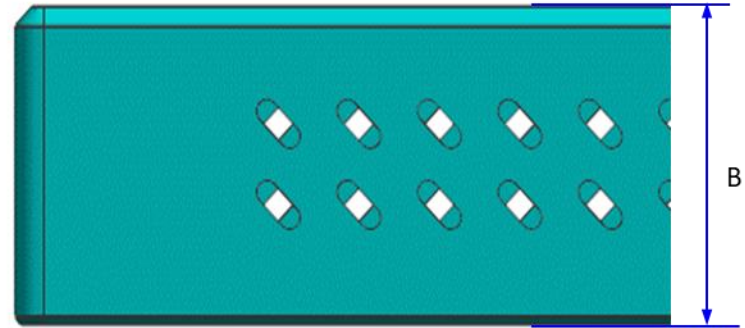
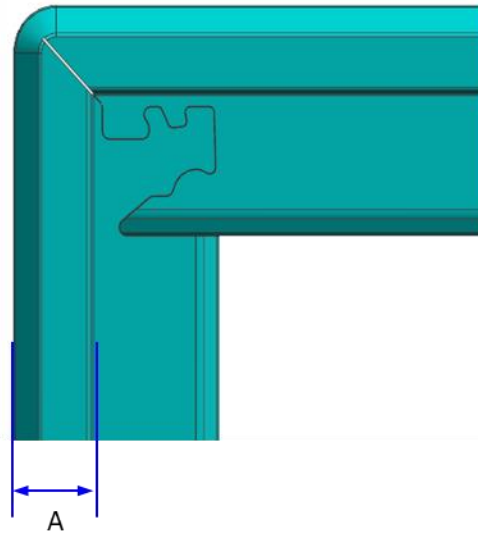

## QN95B Bezel Size

	QN95B							
	55"		65"		75"		85"	
	T/L/R	Bottom	T/L/R	Bottom	T/L/R	Bottom	T/L/R	Bottom
<b>A</b>	3.3	8.4	3.3	8.1	3.3		4.0	10.8
<b>B</b>	17.7		17.7		18.1		18.1	

# QN95B

*\*Dimensions in millimeters (+ / - 0.1 mm)*

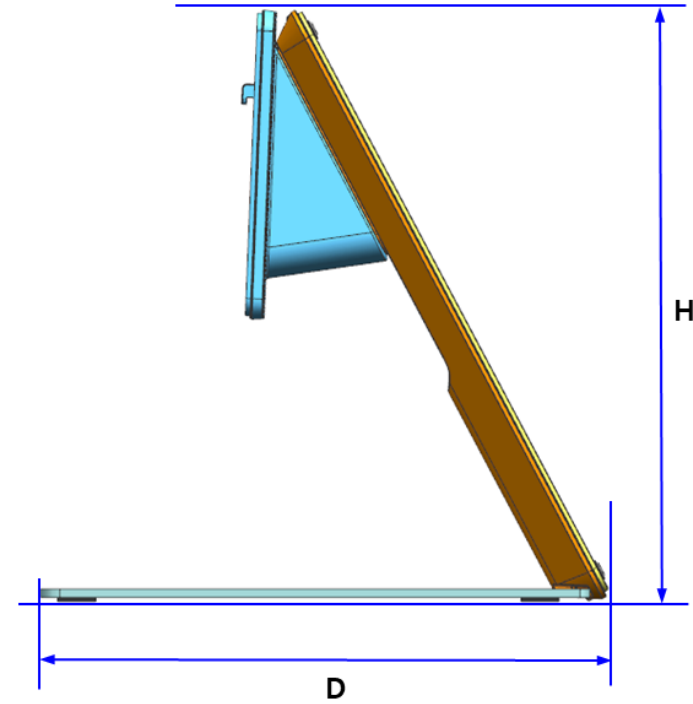
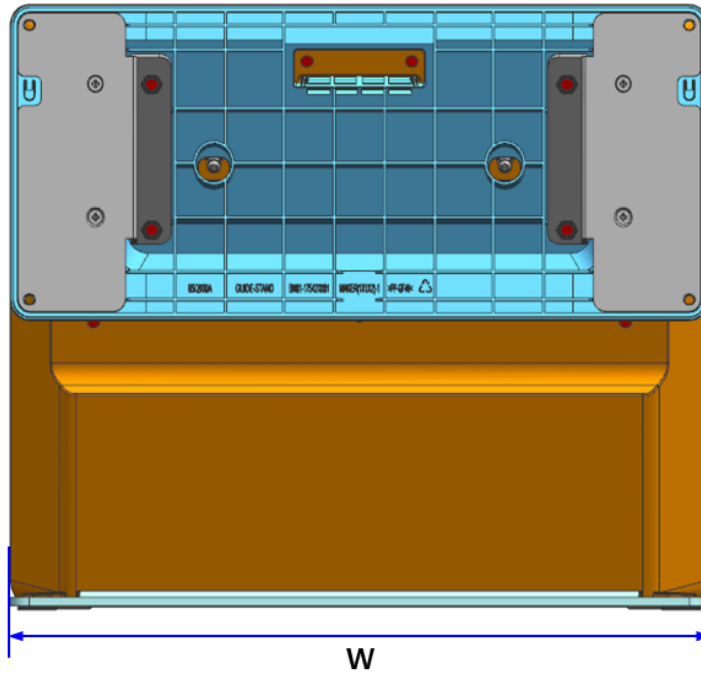

\*Include Rubber-foot

## QN95B Stand Dimension

	QN95B		
	55"/65"	75"	85"
<b>CENTER STAND (W*H*D)</b>	360.0 * 288.8 * 298.4	360.0 * 287.7 * 318.3	360.0 * 288.8 * 341.4

# QN95B

*\*Dimensions in millimeters (+ / - 0.1 mm)*

## QN95B One Connect Box Size

	QN95B
OC BOX (with COVER) (W*H*D)	359.8 * 33.7 * 329.8
OC BOX (without COVER) (W*H*D)	294.9 * 33.7 * 329.8

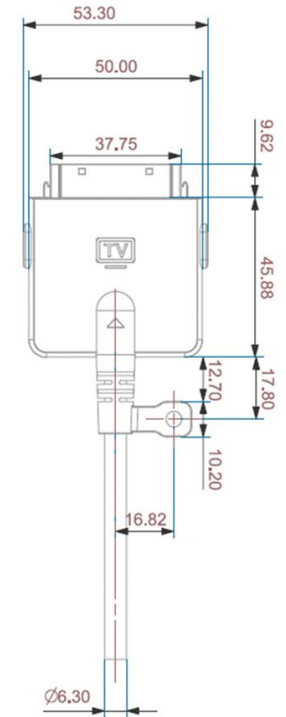
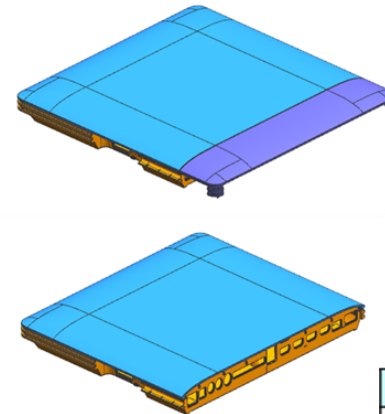
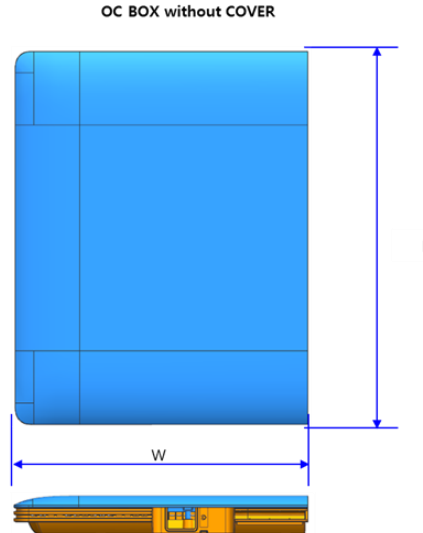
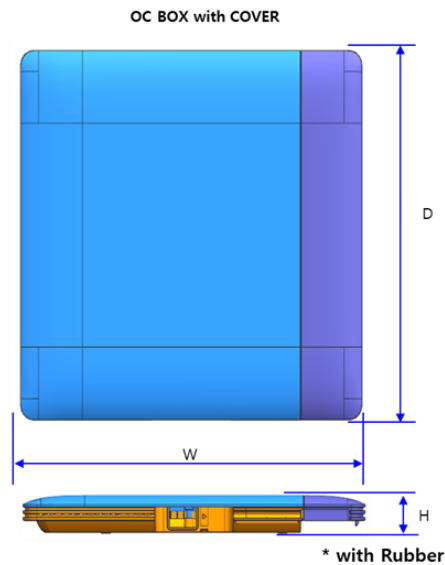

Included OneConnect Cables
0.3M (Short)
2.5M (Long)

## QN95B One Connect Box Vent Area

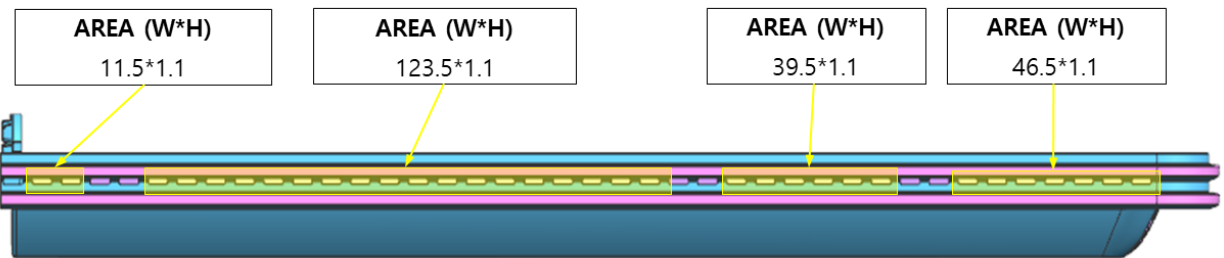
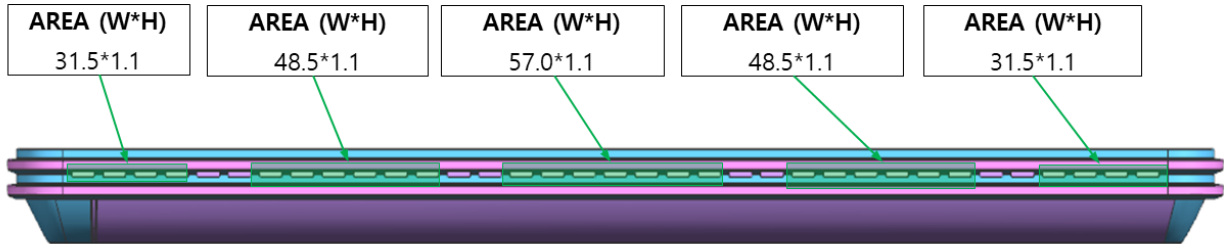
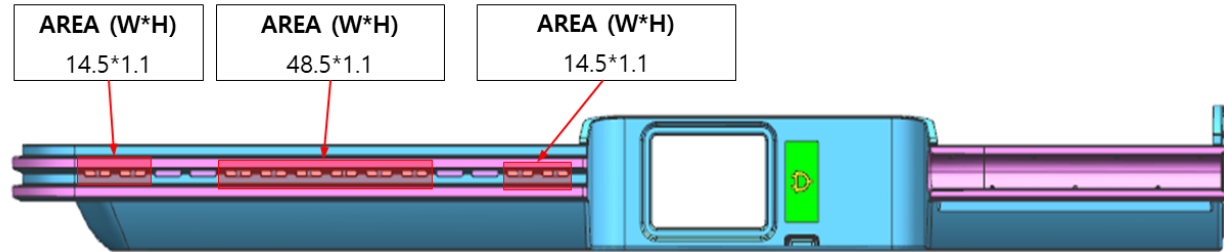

### ※ VENT Detailed Size

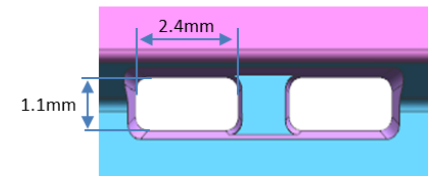

Bottom

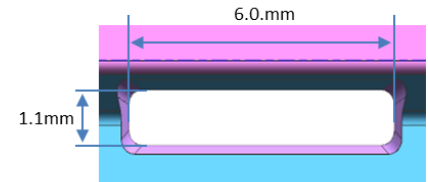

Side

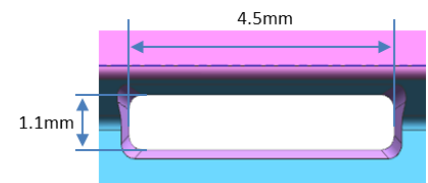

Top

**2022 New Model IR Sensor Information**

As of Apr/01/2022

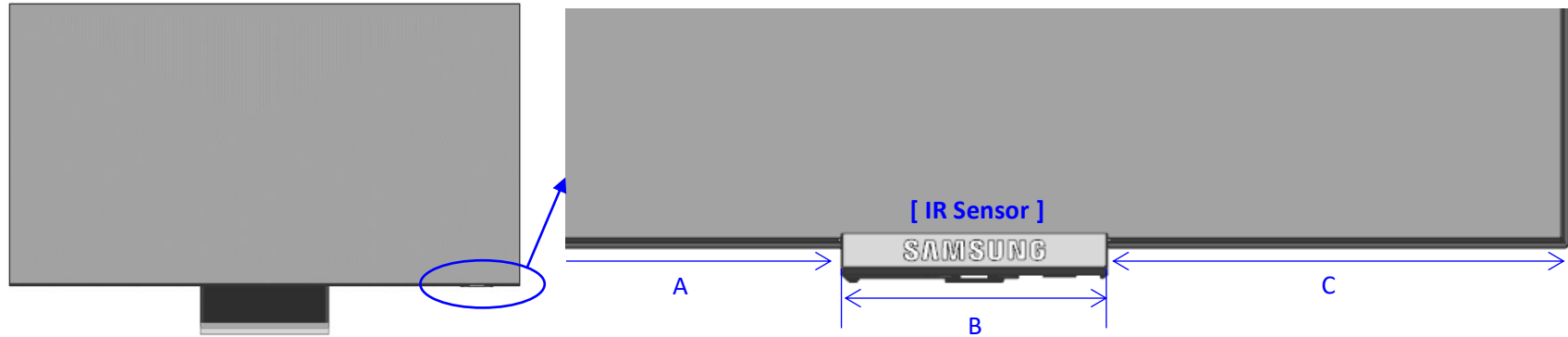

Product	Series	Inch	Item	Sensor Position	DIMENSION		
					A	B	C
Neo QLED 4K	QN95B	85	QN85QN95BAFXZA	Right	1783.50	25.20	85.50
		75	QN75QN95BAFXZA	Right	1570.10	25.20	75.30
		65	QN65QN95BAFXZA	Right	1356.70	25.20	65.00
		55	QN55QN95BAFXZA	Right	1096.45	25.20	106.35