

Product Catalog.

CELLULAR COVERAGE SOLUTIONS FOR
HOME/OFFICE & VEHICLES



Contents

ABOUT US

About weBoost	4
How it Works (Home & Small Office)	6
How it Works (Mobile)	8

HOME & SMALL OFFICE

Product Line-Up	11
weBoost Installed Home Complete	13
Home Complete	15
Home MultiRoom	17
Home Studio	19
Home Room	21

MOBILE

Product Line-Up	25
Drive Reach	27
Drive X	29
Drive Sleek	31
Destination RV	33
Drive Reach RV	35
Drive X RV	37
Drive Reach OTR	39
Drive Sleek OTR	41
Drive X OTR	43
Drive Reach Overland	45

WEBOOST FOR BUSINESS

Product Line-Up	49
weBoost Installed Office 200	51
weBoost Office 200	53
weBoost Office 100	55
Drive Reach Fleet	57
Drive X Fleet	59
Drive Reach OTR Fleet	61
Drive Reach Flex Fleet	63

ACCESSORIES

Antennas (In-Depth)	65
Mounts	76
Cables and Connectors	77
Attenuators	79
Taps	79
Splitters	80
Power Supplies	81
Warranty	83



About weBoost

WE STRENGTHEN YOUR CELLULAR SIGNAL

Call, text, share and connect with the peace of mind that your world is always within reach from virtually anywhere and at any time. To put it simply, weBoost connects.

From your home to your workplace and even on the go, we improve the way you experience everyday wireless communications by providing stronger, more reliable cellular signals while simultaneously enhancing your ability to receive and transmit data. At weBoost, we provide the industry's most advanced line of cellular signal boosters that work with cellular networks and carriers nationwide.

Best-in-class boosters

As a leader in wireless communications, everything we do is about making your cellular signal more reliable. We pioneer products that provide unparalleled cellular connectivity solutions for your car, home and workplace. We hold one of the broadest patent portfolios in our industry. Both voice and data, we enable our customers to take greater control over the most important function of cellular devices: effortless sharing.

Cellular boosters for all carriers

We approach everything we do with a global perspective and insatiable curiosity. We're proud to say that all weBoost products are designed, assembled, and tested at the company's US facilities and are FCC certified where required. weBoost signal boosters work transparently on the network, boosting your cell signal and enabling consistent, seamless communication experiences across all carriers. At weBoost we enable an enriched communication experience for our customers by boosting cellular connectivity through our unique combination of product and industry leadership along with our unparalleled customer support.



Our Story

Founded by Jim Wilson, who as a kid loved amateur radio and after receiving his ham radio license at 14 years old started making antennas in his parent’s garage. And in 1968 started his first of many successful companies, Wilson Antenna, manufacturing and selling CB antennas and two-way radios.

Eventually, Wilson Antenna became the market leader and its products were seen as a status symbol for truckers.

Fueled by Passion

In 1997, Jim was working away from home and wasn’t able to stay connected with his family due to spotty cell phone coverage. This planted the idea for “cell phone signal boosting systems”.

After three years of intense research and development, Jim invented and patented the first cellular signal boosting solution giving way to who we are now, Wilson Electronics. Now, several years later we continue to innovate, develop, and pioneer technology as the industry market leader.

We hold over 110 international patents for boosting cellular signal.

We are passionate about our work



Established in 2000
in St. George, Utah



Recognized global leader
in cellular boosting technology



Market Innovator with over
80 US cellular signal patents

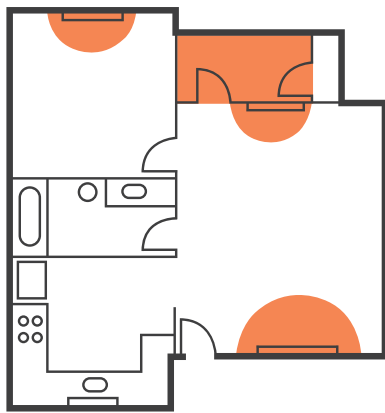

Normal cell coverage

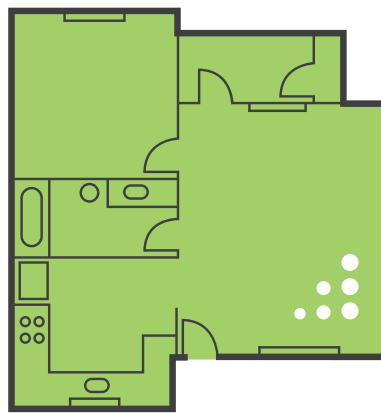

Cell coverage with weBoost

How it Works

HOME & SMALL OFFICE

Dropped calls and slow data are generally caused by three things: distance from a cell tower, building materials in your home or office, or obstruction from tall objects such as trees, topography, and buildings.

weBoost devices are able to capture an exterior signal—even one that is far away—and amplify it in your car, home, or office. weBoost devices work on every network, for any carrier, to give you up to 32x your cell signal strength.

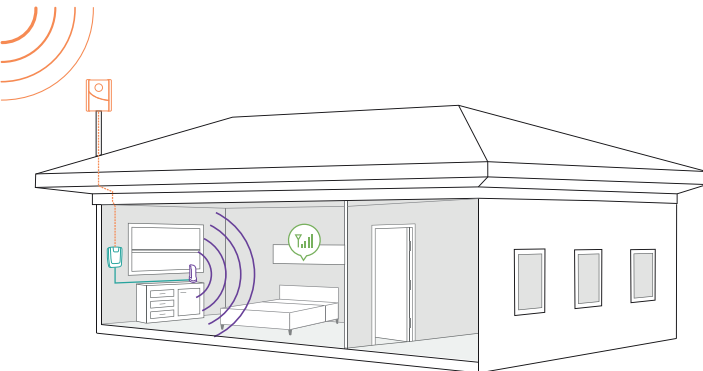
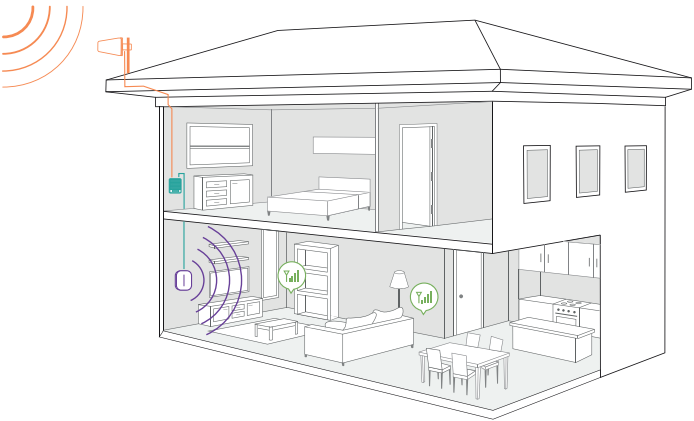
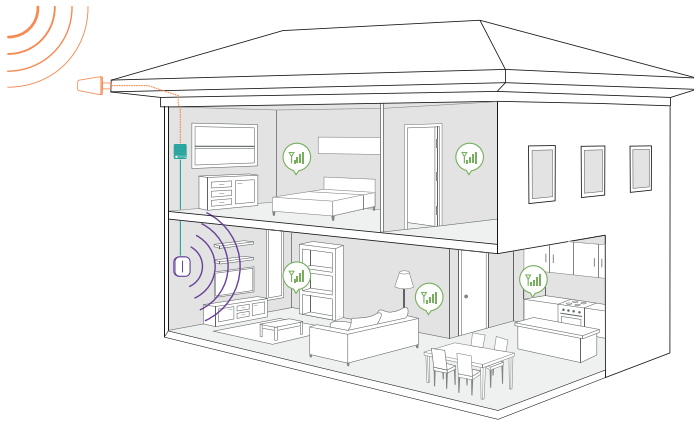

How to boost a cell signal

Signal boosters increase cell signal by collecting signals with a powerful antenna, delivering those signals to the booster, amplifying the cell signals so your devices receive them, and delivering your device's boosted signals back to the cell tower.

1 RECEIVES SIGNAL

The powerful antenna reaches out to access a voice and data signal, and delivers it to the booster.

2 BOOST SIGNAL

The booster receives the signal, amplifies it, and serves as a relay between your phone and the nearest cell tower.

3 BROADCASTS SIGNAL

Your devices get a stronger signal, and calls and data are fed through the booster back to the network.

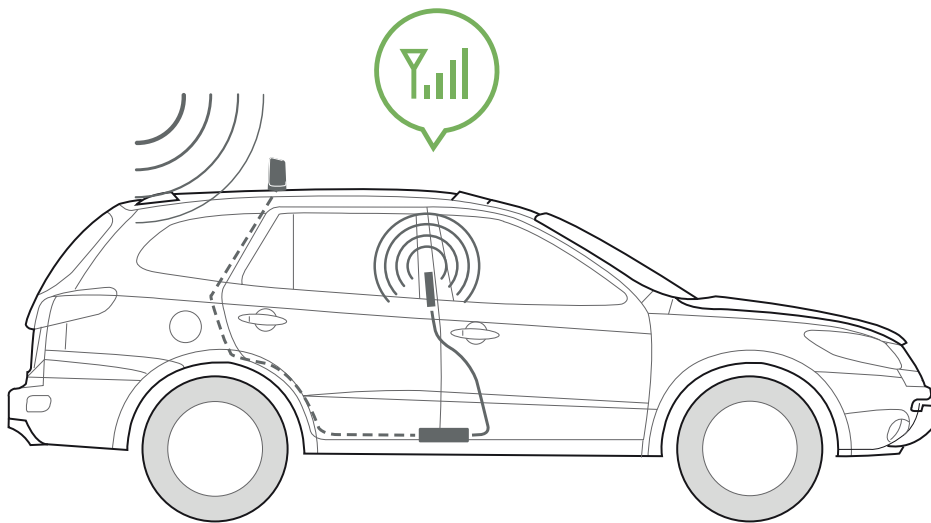

How it Works

MOBILE

Dropped calls and slow data are generally caused by three things: distance from a cell tower, the frame of the vehicle itself, or obstruction from tall objects such as trees, topography, and buildings.

weBoost devices are able to capture an exterior signal—even one that is far away—and amplify it in your car, home, or office. weBoost devices work on every network, for any carrier, to give you up to 32x your cell signal strength.

FAMILY VEHICLES

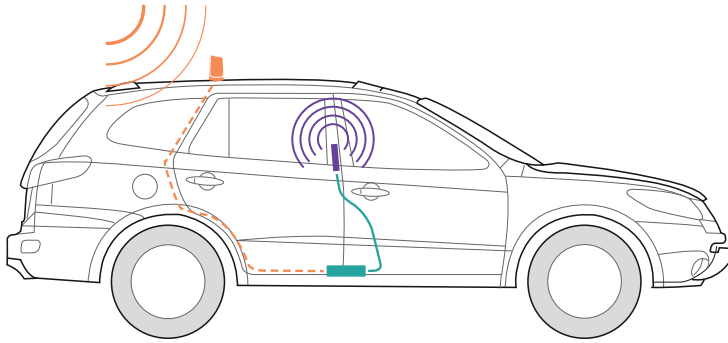

TRUCK AND COMMERCIAL

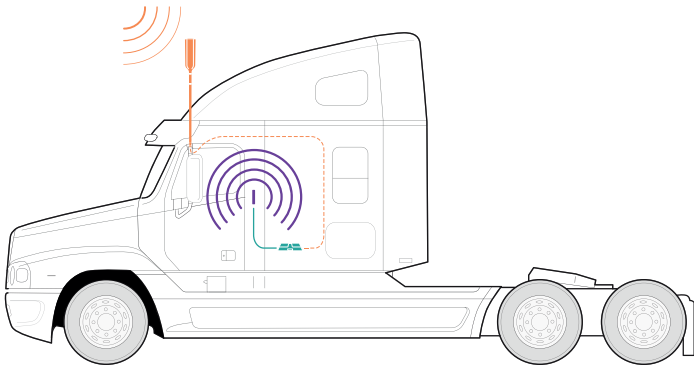

RECREATIONAL VEHICLES

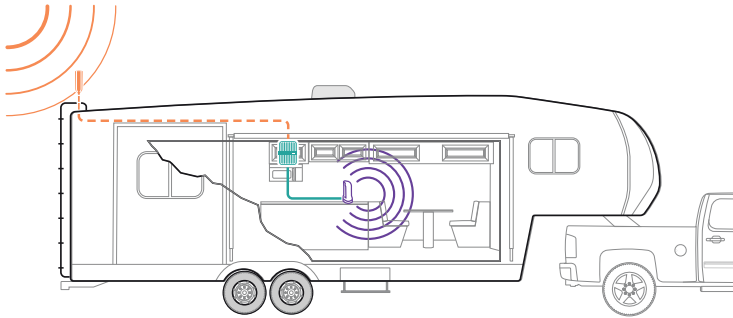

FLEET VEHICLES

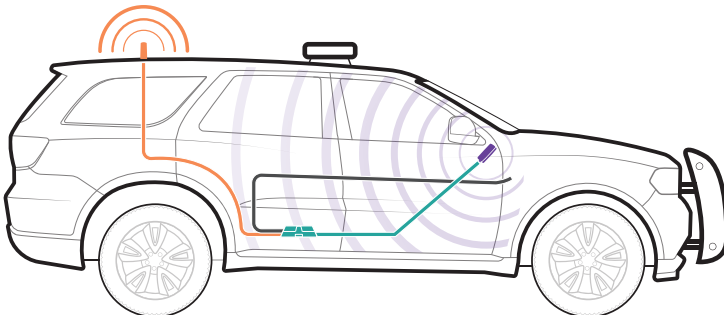

How to boost a cell signal

Signal boosters increase cell signal by collecting signals with a powerful antenna, delivering those signals to the booster, amplifying the cell signals so your devices receive them, and delivering your device's boosted signals back to the cell tower.

1 RECEIVES SIGNAL

The powerful antenna reaches out to access a voice and data signal, and delivers it to the booster.

2 BOOST SIGNAL

The booster receives the signal, amplifies it, and serves as a relay between your phone and the nearest cell tower.

3 BROADCASTS SIGNAL

Your devices get a stronger signal, and calls and data are fed through the booster back to the network.



Home & Small Office

Product Line Up

weBoost Home and Small Office Boosters



weBoost Installed Home Complete
474445
\$1,299.99



Home Complete
470145
\$999.99



Home MultiRoom
470144
\$569.99



Home Studio
470166
\$349.99



Home Room
472120
\$399.99

COMPATIBILITY	Boosts signal on all available network speeds	Boosts signal on all available network speeds	Boosts signal on all available network speeds	Boosts signal on all available network speeds	Boosts signal on all available network speeds
PROFESSIONAL INSTALLATION INCLUDED	X				
If the cell signal outside your home is: Strong	Max Coverage	Max Coverage	Multiple Rooms	Large Room	Large Room
If the cell signal outside your home is: Good	Multiple Rooms	Multiple Rooms	Large Room	Medium Room	Medium Room
If the cell signal outside your home is: Weak	Single Room	Single Room	Medium Room	Small Room	Small Room
If the cell signal outside your home is: None	None	None	None	None	None
CABLE	RG6 Cable Lengths will vary Provided by Installer	60' + 75' Black RG11 cable (951160) (951175)	15' (x2) & 30' Cables (YX030-15W), (950630)	30' Coax Cables (x2) (950630)	30' White Low Loss RG6 (75ohm) Coax Cable (x2) (950630)

UPC

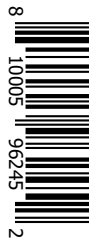

⚠ See the individual product pages for applicable Prop 65 Warnings.

Product Line Up

weBoost Home and Small Office Boosters



weBoost Installed Home Complete
474445

\$1,299.99



Home Complete
470145

\$999.99



Home MultiRoom
470144

\$569.99



Home Studio
470166

\$349.99



Home Room
472120

\$399.99

EXTERNAL ANTENNA	Outside Directional Antenna (314445)	Outside Directional Antenna (314445)	Outside Directional Antenna (314445)	Outside Directional Antenna (314445)	Outside Panel Antenna (314473)
INTERNAL ANTENNA	Fabric Inside Panel Antenna (314440)	Fabric Inside Panel Antenna (314440)	Fabric Inside Panel Antenna (314440)	Booster Antenna (311159)	Inside Desktop Antenna (301211)
FREQUENCIES MHZ	Band 12/17 700 Band 13 700 Band 5 850 Band 4 1700/2100 Band 25/2 1900	Band 12/17 700 Band 13 700 Band 5 850 Band 4 1700/2100 Band 25/2 1900	Band 12/17 700 Band 13 700 Band 5 850 Band 4 1700/2100 Band 25/2 1900	Band 12/17 700 Band 13 700 Band 5 850 Band 4 1700/2100 Band 25/2 1900	Band 12/17 700 Band 13 700 Band 5 850 Band 4 1700/2100 Band 2 1900
MAX GAIN	72 dB	72 dB	65 dB	60 dB	60 dB
IMPEDANCE	75 Ohm	75 Ohm	75 Ohm	75 Ohm	75 Ohm
POWER	110-240V AC, 50-60 Hz, 20 W	110-240V AC, 50-60 Hz, 20 W	110-240 V AC, 50-60 Hz, 17.5 W	110-240V AC, 60-80 Hz, 10.5 W	110-240V AC, 50-60 Hz, 15 W
CONNECTORS	F-Female	F-Female	F-Female	F-Female SMA-Female	SMA Female / F-Female
BOOSTER DIMENSIONS	8.25 x 6 x 2.4 in	8.25 x 6 x 2.4 in	6. x 6 x 1.6 in.	6.125 x 3.875 x 1.125 in.	6.5 x 4.25 x 1.25 in.
BOOSTER WEIGHT	1.55 lbs	1.55 lbs	1.9 lbs.	10.2 oz.	0.455 lbs.

UPC



FOR PARTNER'S USE

Website: <http://support.weboost.com>

Phone: +1 866 294 1660
Monday to Saturday

⚠ See the individual product pages for applicable Prop 65 Warnings.

weBoost Installed | Home Complete

SKU: 474445 MAP: \$1,299.99

FEATURES

- First residential cell signal solution to include professional installation anywhere in U.S.
- Boosts all available networks speeds for enhanced cell signal coverage
- Max cell coverage for your home
- Supports multiple cellular devices and users simultaneously
- Works with all US carriers; Verizon, AT&T, T-Mobile, and more

About

The **weBoost Installed | Home Complete** cell signal booster provides a best-in-class solution for weak or nonexistent indoor cellular coverage. It's engineered to increase network speeds across all available signal bands for max coverage throughout a home. The weBoost Installed | Home Complete benefits from improved aesthetics to complement contemporary décor; as evidenced by the anodized-gray and powder-coated-black aluminum booster and its fabric-covered inside panel antenna. Upon receipt of the product, professional installation can be scheduled as soon as the next day; anywhere in the United States. After home installation, customers will experience faster data speeds, fewer dropped calls, superior streaming capability, and more. weBoost Installed | Home Complete works with all US carriers; which includes AT&T, Verizon, T-Mobile, US Cellular, and Straight Talk. It comes with a 2-year manufacturer's warranty along with a 30-day money-back guarantee.

Coverage Area

IF THE CELL SIGNAL OUTSIDE YOUR HOME IS:	YOUR BOOSTED CELL SIGNAL WILL COVER:
Strong	→ Max Coverage
Good	→ Multiple Rooms
Weak	→ Single Room
None	→ None

† **WARNING:** This product can expose you to chemicals including Nickel, which is known to the State of California to cause cancer, and Bisphenol A, which is known to the State of California to cause birth defects or other reproductive harm. For more information go to www.P65Warnings.ca.gov



Kit Includes

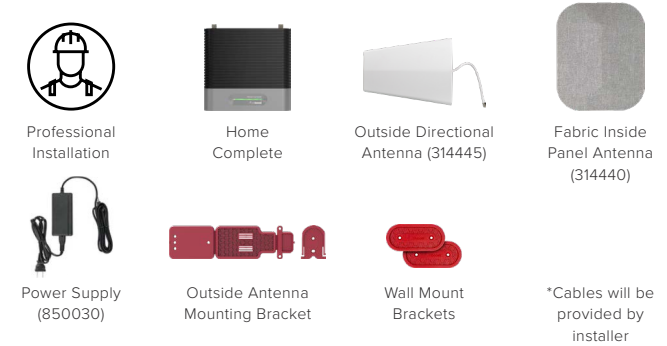

Specifications

SKU NUMBER	474445 [†]	
FREQUENCIES	Band 12/17	700 MHz
	Band 13	700 MHz
	Band 5	850 MHz
	Band 4	1700/2100 MHz
	Band 25/2	1900 MHz
MAX GAIN	72 dB	
IMPEDANCE	75 Ohm	
POWER	110-240V AC, 50-60 Hz, 20 W	
CONNECTORS	F-Female	
BOOSTER DIMENSIONS	8.25 x 6 x 2.4 in	
BOOSTER WEIGHT	1.55 lbs	

How the weBoost Installed Works

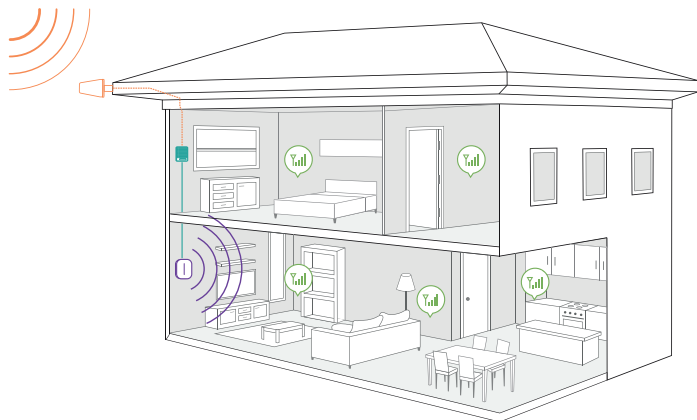

- 1 **Receives signal:** The outside antenna reaches out to access the existing strong outdoor cell signal and delivers it indoors to the booster.
- 2 **Boost signal:** The booster receives the signal, amplifies it, and serves as a relay between your phone and the nearest cell tower.
- 3 **Broadcasts signal:** Your devices get a stronger signal, and calls and data are fed through the booster back to the network.

Package Dimensions (Approx.)

13.5 L x 9 W x 11.5 H

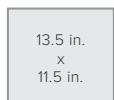

FRONT

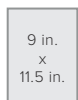

SIDE

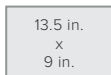

TOP/BOTTOM



WEIGHT

MASTER CARTON: 25 L x 19.25 W x 14.25 H | 3775 Lbs. | Qty 4

FOR PARTNER'S USE

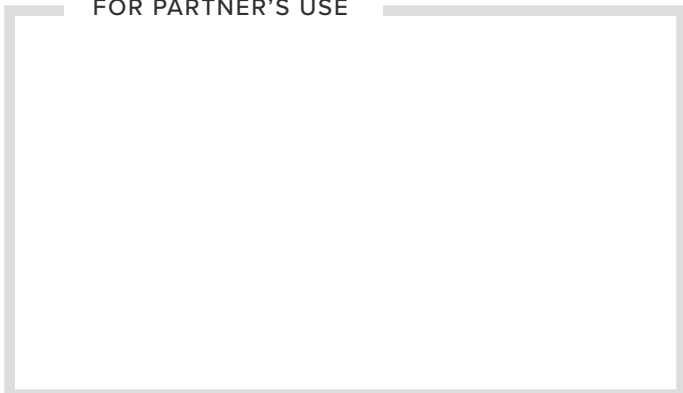

474445_weBoost Installed | Home Complete_SS_012822

Support

2-Year Warranty from Purchase.

Website: <http://support.weboost.com>

Phone: +1 866 294 1660
Monday to Saturday

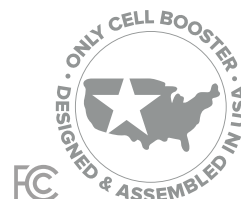

UPC



Home Complete

SKU: 470145 MAP: \$999.99

FEATURES

- Boosts all available networks speeds for enhanced cell signal coverage
- Offers an ideal solution for homeowners and residents
- Supports multiple cellular devices and users simultaneously
- Works with all US carriers; Verizon, AT&T, T-Mobile, UScellular, and more



- 5G COMPATIBLE**
- MAX COVERAGE**
- UP TO +72 dB GAIN**
- MULTI-USER WIRELESS BOOSTER**

About

The weBoost **Home Complete** is the best-in-class booster for those who like to get it done. Everything needed for installation in a home is included. Once installed, this powerful booster improves cell signal on all US carrier networks, including Verizon, AT&T, T-Mobile, and more. Its contemporary design and 5G compatible coverage ensure it will work for the next decade and beyond. Like all weBoost solutions, it comes with an installation guide, a 2-year manufacturer's warranty, and a 30-day money-back guarantee.

Kit Includes

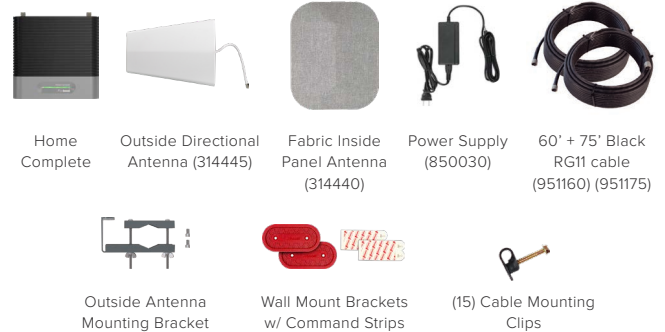

Coverage Area

IF THE OUTSIDE CELL SIGNAL IS:	YOUR BOOSTED CELL SIGNAL MAY COVER:
Strong	→ Max Coverage
Good	→ Multiple Rooms
Weak	→ Single Room
None	→ None

Specifications

SKU NUMBER	470145 [†]
FREQUENCIES	Band 12/17 700 MHz Band 13 700 MHz Band 5 850 MHz Band 4 1700/2100 MHz Band 25/2 1900 MHz
MAX GAIN	72 dB
IMPEDANCE	75 Ohm
POWER	110-240V AC, 50-60 Hz, 20 W
CONNECTORS	F-Female
BOOSTER DIMENSIONS	8.25 x 6 x 2.4 in
BOOSTER WEIGHT	1.55 lbs

[†]**WARNING:** This product can expose you to chemicals including Nickel, which is known to the State of California to cause cancer, and Bisphenol A, which is known to the State of California to cause birth defects or other reproductive harm. For more information go to www.P65Warnings.ca.gov

How It Works

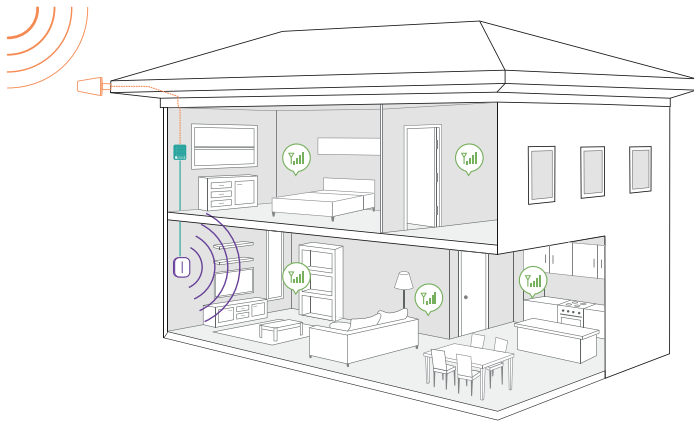

- 1 Receives signal:** The outside antenna reaches out to access the existing strong outdoor cell signal and delivers it inside to the booster.
- 2 Boost signal:** The booster receives the signal, amplifies it, and serves as a relay between your phone and the nearest cell tower.
- 3 Broadcasts signal:** Your devices get a stronger signal, and calls and data are fed through the booster back to the network.

Available Accessories



Inside Panel Antenna
with mount
(314444)



Outside Directional
Antenna with mount
(314445)



75' RG-11 Extension
Cable with F Male
Connectors
(951175)



Splitters 75 Ohm
(850034, 850035,
850036)



Lightning Surge
Protector 75 Ohm
(859992)

Package Dimensions

17.75 L x 12.25 W x 12.25 H

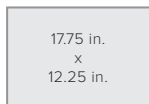

FRONT

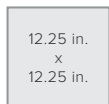

SIDE

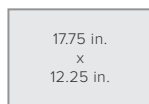

TOP/BOTTOM



WEIGHT

MASTER CARTON: 25 L x 20 W x 15 H | 36.60 Lbs. | Qty 2

Support



2-Year Warranty from Purchase.

Website: <http://support.weboost.com>

Phone: +1 866 294 1660
Monday to Saturday



FOR PARTNER'S USE

UPC

470145



8 11815 02948 9

470145_Home-Complete_SS_011021

Home MultiRoom

SKU: 470144 MAP: \$569.99

FEATURES

- Stylish, MultiRoom-exclusive Inside Antenna.
- Powerful, precision-mount Outside Antenna.
- Enhances cell coverage for up to 3 large rooms.
- Tool-free installation. No need to drill holes.

† ⚠ WARNING: This product can expose you to chemicals including Nickel, which is known to the State of California to cause cancer, and Bisphenol A, which is known to the State of California to cause birth defects or other reproductive harm. For more information go to www.P65Warnings.ca.gov

About

The weBoost **Home MultiRoom** cell signal booster boosts networks speeds across all available signal bands (including Band 25 for enhanced Sprint support) for up to three large rooms.

The Home MultiRoom also features an exclusive, Inside Antenna—featuring a built-in kickstand and stylish fabric cover while also providing best-in-class performance. Wall-mount installation is effortless with the included 3M® Command™ strips. The proprietary Outside Antenna offers a tool-free, finger-tightened precision mount. Users will experience faster data speeds, better voice quality, fewer dropped calls, and superior streaming capability. Home MultiRoom works with all US carriers—including Verizon, AT&T, T-Mobile, and more.

It also comes with 2-year manufacturer’s warranty, and 30-day money-back guarantee.

Coverage Area

IF THE CELL SIGNAL OUTSIDE YOUR HOME IS:	YOUR BOOSTED CELL SIGNAL WILL COVER:
Strong	→ Multiple Rooms
Good	→ Large Room
Weak	→ Medium Room
None	→ None



- BOOSTS SIGNAL ON ALL AVAILABLE NETWORK SPEEDS
- UP TO +65 dB GAIN
- MULTI-USER WIRELESS BOOSTER

Kit Includes



Specifications

MODEL NUMBER	470144†
FREQUENCIES	Band 12/17 700 MHz Band 13 700 MHz Band 5 850 MHz Band 4 1700/2100 MHz Band 25/2 1900 MHz
MAX GAIN	65 dB
IMPEDANCE	75 Ohm
POWER	110-240 V AC, 50-60 Hz, 8 W
CONNECTORS	F-Female
BOOSTER DIMENSIONS	6 x 6 x 1.6 in.
BOOSTER WEIGHT	1.9 lbs.

Installation

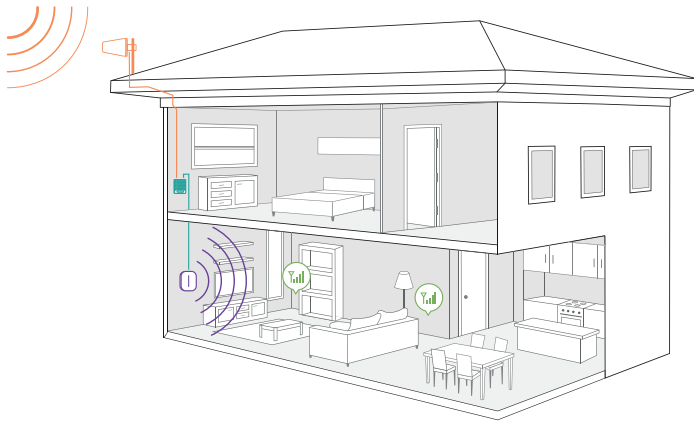

- 1 Receives signal:** The outside antenna reaches out to access the existing strong outdoor cell signal and delivers it into the booster.
- 2 Boost signal:** The booster receives the signal, amplifies it, and serves as a relay between your phone and the nearest cell tower.
- 3 Broadcasts signal:** Your devices get a stronger signal, and calls and data are fed through the booster back to the network.

Available Accessories



Plastic Inside
Panel Antenna
314444



Lightning Surge
Protector 75 Ohm
859992*



-3dB 2-Way
Splitter 75 Ohm
850034*



20 ft. White RG6
Low Loss Coax
950620*



F-Female to
F-Female Barrel
Connector
971129*

Package Dimensions

9.313 L x 14 W x 11.375 H

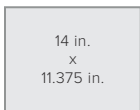

FRONT

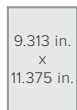

SIDE

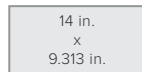

TOP/BOTTOM



WEIGHT

MASTER CARTON: 25.5 L x 19.5 W x 15.5 H | 43.8 lbs. | QTY 4

Support



2-Year Warranty from Purchase.

Website: <http://support.weboost.com>

Phone: +1 866 294 1660
Monday to Saturday



FOR PARTNER'S USE

UPC

470144



8 10005 96128 8

470144_HomeMultiRoom_SS_Rev01_110221

Home Studio

SKU: 470166 MAP: \$349.99

FEATURES

- Boosts network speeds for multiple users and devices
- Improves cell signal strength and reliability in one large space
- Compact booster with attached antenna fits on a shelf
- Works with all U.S. carrier networks including Verizon, AT&T, T-Mobile, and UScellular



- 5G READY
- COVERAGE FOR ONE ROOM
- UP TO +60 dB GAIN
- MULTI-USER WIRELESS BOOSTER

About

The **weBoost Home Studio** cell signal booster provides a strong solution for weak indoor cellular coverage in home offices, living rooms, or apartments. It's engineered to increase network speeds across several signal bands in a large room. Additionally, it's ready for 5G and will continue to boost cell signal for the next decade and beyond. The Home Studio also benefits from an easier installation with an inside antenna that attaches directly to a powerful booster. Once installed, customers will experience fewer missed messages, better voice and video quality, and faster data speeds. The booster kit supports multiple users and devices at one time. It's compatible with all U.S. carrier networks including Verizon, AT&T, T-Mobile, and UScellular. Proudly designed and assembled in the USA, all weBoost booster kits are backed by a 2-year warranty and 30-day money-back guarantee.

Kit Includes



Coverage Area

IF THE CELL SIGNAL OUTSIDE YOUR HOME IS:	YOUR BOOSTED CELL SIGNAL WILL COVER:
Strong	→ Large Room
Medium	→ Medium Room
Weak	→ Small Room
None	→ None

Specifications

SKU NUMBER	470166†	
FREQUENCIES	Band 12/17	700 MHz
	Band 13	700 MHz
	Band 5	850 MHz
	Band 4	1700/2100 MHz
	Band 25/2	1900 MHz
MAX GAIN	60 dB	
IMPEDANCE	75 Ohm	
POWER	110-240V AC, 60-80 Hz, 20 W	
CONNECTORS	F-Female SMA-Male	
BOOSTER DIMENSIONS	6.125 x 3.875 x 1.125 in.	
BOOSTER WEIGHT	10.2 oz.	

† **WARNING:** This product can expose you to chemicals including Nickel, which is known to the State of California to cause cancer, and Bisphenol A, which is known to the State of California to cause birth defects or other reproductive harm. For more information go to www.P65Warnings.ca.gov

How the Home Studio Works

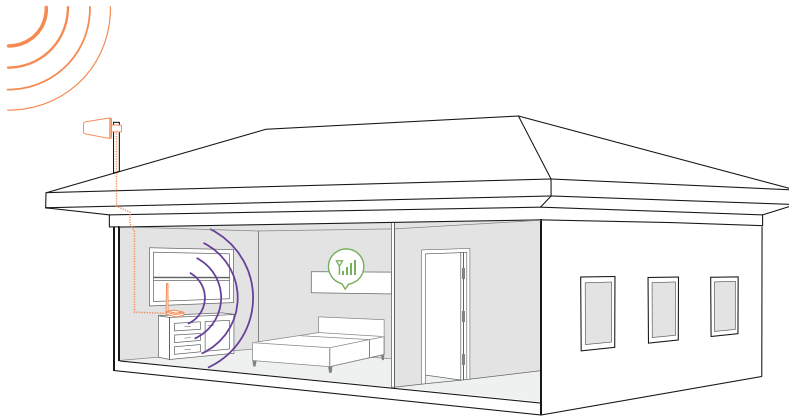

- 1 Receives signal:** The outside antenna reaches out to access the existing strong outdoor cell signal and delivers it inside to the booster.
- 2 Boost signal:** The booster receives the signal, amplifies it, and serves as a relay between your phone and the nearest cell tower.
- 3 Broadcasts signal:** The attached antenna then broadcasts the amplified cell signal to your device. You receive a stronger signal as calls and data are fed through the booster back to the network.

Package Dimensions (Approx.) Support

8.63 L x 13 W x 7.38 H



MASTER CARTON: 24.9 L x 16.55 W x 14.5 H | 33.23 lbs. | Qty 5



2-Year Warranty from Purchase.

Website: <http://support.weboost.com>

Phone: +1 866 294 1660
Monday to Saturday



FOR PARTNER'S USE

UPC



470166_weBoost Home Studio_SS_011521

Home Room

SKU: 472120 MAP: \$399.99

FEATURES

- Boosts cellular signals for a desktop workspace area at home or small office.
- For multiple devices and users.
- Works on ALL cellular devices with ALL carriers simultaneously.
- Enhances talk, text, and high-speed internet.

⚠️ WARNING: This product can expose you to chemicals including Nickel, which is known to the State of California to cause cancer, and Bisphenol A, which is known to the State of California to cause birth defects or other reproductive harm. For more information go to www.P65Warnings.ca.gov



- BOOSTS SIGNAL ON ALL AVAILABLE NETWORK SPEEDS
- UP TO +60 dB GAIN
- MULTI-USER WIRELESS BOOSTER

About

The **Home Room** ensures you get better voice and data with fewer dropped calls, improved voice quality, faster uploads and downloads. This premier home signal booster can increase cell signals up to 32x while enhancing cellular signals.

weBoost's Home Room is compatible with all US networks including Verizon, AT&T, T-Mobile, US Cellular, Straight Talk and more. Each device comes with everything you need for complete installation including an indoor antenna, outdoor antenna, power supply, 30' cable, and trained support staff on call to assist with the DIY installation.

All boosters come with a 2-year warranty.

Kit Includes



Home Room



Outside Panel Antenna (311155)



Inside Desktop Antenna (301211)



Power Supply (850012)



30' White Low Loss RG6 (75ohm) Coax Cable (x2) (950630)



Flat Window Cable (951177)

Specifications

MODEL NUMBER	472120†	
FREQUENCIES	Band 12/17	700 MHz
	Band 13	700 MHz
	Band 5	850 MHz
	Band 4	1700/2100 MHz
	Band 2	1900 MHz
MAX GAIN	60 dB	
IMPEDANCE	75 Ohm	
POWER	110-240V AC, 50-60 Hz, 8 W	
CONNECTORS	SMA Female / F-Female	
BOOSTER DIMENSIONS	6.5 x 4.25 x 1.25 in.	
BOOSTER WEIGHT	0.445 lbs.	

Coverage Area

IF THE CELL SIGNAL OUTSIDE YOUR HOME IS:	→	YOUR BOOSTED CELL SIGNAL WILL COVER:
Strong	→	Large Room
Medium	→	Medium Room
Weak	→	Small Room
None	→	None

Installation

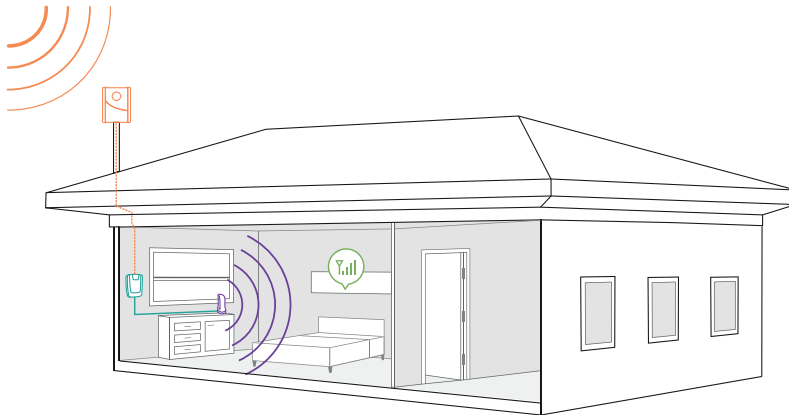

- 1 Receives signal:** The powerful antenna reaches out to access voice and data signals, and delivers it to the booster.
- 2 Boost signal:** The booster receives the signal, amplifies it, and serves as a relay between your phone and the nearest cell tower.
- 3 Broadcasts signal:** Your devices get a stronger signal, and calls and data are fed through the booster back to the network.

Available Accessories

Optional Antenna Kits



Lightning Surge
Protector 75 Ohm
859992*



RG-6 F-Male /
F-Male, 2ft. White
Cable
950602*



20 ft. White RG6
Low Loss Coax
950620*



F-Female to
F-Female Barrel
Connector
971129*



Inside Antenna
Upgrade Kit
304447*

Package Dimensions

5.25 L x 14.5 W x 11.25 H



FRONT

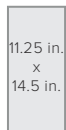

SIDE

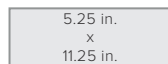

TOP/BOTTOM



WEIGHT

MASTER CARTON: 25 L x 18 W x 16 H | 43 Lbs. | QTY 6

FOR PARTNER'S USE

Support



2-Year Warranty from Purchase.

Website: <http://support.weboost.com>

Phone: +1 866 294 1660
Monday to Saturday



UPC



472120_HomeRoom_SS_Rev02_110221



Mobile

Product Line Up

weBoost Mobile Boosters



Drive Reach
470154

\$499.99



Drive X
475021

\$399.99



Drive Sleek
470135

\$199.99



Destination RV
470159

\$649.99



Drive Reach RV
470354

\$519.99



Drive X RV
471410

\$449.99



Drive Reach OTR
472154

\$519.99



Drive Sleek OTR
470235

\$279.99



Drive X Fleet
473021

\$424.99



Drive Reach Overland
472061

\$549.99

COMPATIBILITY	Boosts signal on all available network speeds									
---------------	---	--	--	--	--	--	--	--	--	--

Max Uplink Output Power	27.3 dBm	24.8 dBm	25.6 dBm	29.9 dBm	27.3 dBm	24.84 dBm	27.3 dBm	25.56 dBm	24.84 dB	27.3 dBm
-------------------------	----------	----------	----------	----------	----------	-----------	----------	-----------	----------	----------

Max Downlink Output Power	7.8 dBm	2.9 dBm	2.5 dBm	16.0 dBm	7.8 dBm	2.87 dBm	7.8 dBm	2.5 dBm	2.87 dB	7.8 dBm
---------------------------	---------	---------	---------	----------	---------	----------	---------	---------	---------	---------

Max Gain	50 dB	50 dB	23 dB	65 dB Stationary use only	50 dB	50 dB	50 dB	23 dB	50 dB	50 Ohm
----------	-------	-------	-------	------------------------------	-------	-------	-------	-------	-------	--------

Most Powerful	✓			✓ Stationary use only						✓
---------------	---	--	--	--------------------------	--	--	--	--	--	---

MULTIPLE USERS	✓	✓		✓	✓	✓	✓		✓	✓
----------------	---	---	--	---	---	---	---	--	---	---

SINGLE USER ONLY			✓					✓		
------------------	--	--	---	--	--	--	--	---	--	--

UPC										
-----	--	--	--	--	--	--	--	--	--	--

⚠ See the individual product pages for applicable Prop 65 Warnings.

Product Line Up

weBoost Mobile Boosters



Drive Reach
470154

\$499.99



Drive X
475021

\$399.99



Drive Sleek
470135

\$199.99



Destination RV
470159

\$649.99



Drive Reach RV
470354

\$519.99



Drive X RV
471410

\$449.99



Drive Reach OTR
472154

\$519.999



Drive Sleek OTR
470235

\$279.99



Drive X Fleet
473021

\$424.99



Drive Reach Overland
472061

\$549.99

EXTERNAL ANTENNA	Mini Magnet-Mount Antenna (311216)	Mini Magnet-Mount Antenna (301126)	Magnetic Mount Antenna (311250)	Directional Antenna (314445)	Drive RV Outside Antenna (311230)	Drive RV Outside Antenna (311230)	Drive OTR Antenna (311229)	Drive OTR Outside Antenna (311229)	NMO Antenna (314405)	Overland Antenna (311248)
INTERNAL ANTENNA	Slim Low-Profile Antenna (314401)	Slim Low-Profile Antenna (314401)	Built into Cradle	Panel Antenna (311239)	Desktop Inside Antenna (301211)	Drive X RV Inside Antenna (311160)	Slim Low-Profile Antenna (314401)	Built into Cradle	Slim Low-Profile Antenna (314401)	Inside Antenna (314401)
FREQUENCIES MHZ	Band12/17 700 Band13 700 Band 5 850 Band 4 1700/2100 Band 25/2 1900									
MAX GAIN	50 dB	50 dB	23 dB	65 dB Stationary use only	50 dB	50 dB	50 dB	23 dB	50 dB	50 dB
IMPEDANCE	50 Ohm	50 Ohm	50 Ohm	75 Ohm	50 Ohm	50 Ohm	50 Ohm	50 Ohm	50 Ohm	50 Ohm
POWER	12V DC 1.8A	12V DC 1.2A	12V DC 1.5A	110-240 V AC	12V DC 1.8A	12V DC 1.2A	12V DC 1.8A	12V DC 1.5A	6V/ 2.5A	12V 1.8A
CONNECTORS	SMA Female	SMA Female	SMB	F Female	SMA Female	SMA Female	SMA Female	SMB	SMA	SMA Male & SMA Female
BOOSTER DIMENSIONS	6 x 4.5 x 1.5 in.	6.25 x 4.5 x 1 in.	.65 x 1.60 x 7 in.	6 x 6 x 1.6 in.	6 x 4.5 x 1.5 in.	6.25 x 4.25 x 1 in.	6 x 4.5 x 1.5 in.	.65 x 1.60 x 7 in.	6.25 x 4.5 x 1 in.	6 x 4.5 x 1.5 in.
BOOSTER WEIGHT	1.80 lbs.	0.77 lbs.	.55 lbs.	1.9 lbs.	1.80 lbs.	0.8 lbs.	1.80 lbs.	.55 lbs.	.77 lbs.	1.8 lbs.

UPC

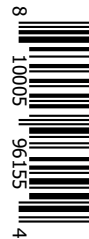
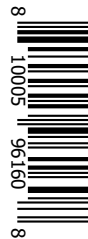
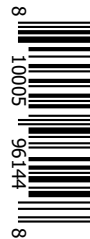

FOR PARTNER'S USE

Website: <http://support.weboost.com>

Phone: +1 866 294 1660
Monday to Saturday

⚠ See the individual product pages for applicable Prop 65 Warnings.

Drive Reach

SKU: 470154 MAP: \$499.99

FEATURES

- Enhances all available wireless network signals and speeds throughout a passenger vehicle — car, truck, van, or SUV.
- Works on ALL cellular devices with ALL carriers simultaneously.
- Improves talk, text, and high-speed internet.

⚠️ WARNING: This product can expose you to chemicals including Nickel, which is known to the State of California to cause cancer, and Bisphenol A, which is known to the State of California to cause birth defects or other reproductive harm. For more information go to www.P65Warnings.ca.gov



- BOOSTS SIGNAL ON ALL AVAILABLE NETWORK SPEEDS
- FAST NETWORK SPEEDS
- UP TO +50 dB GAIN
- MULTI-USER WIRELESS BOOSTER

Kit Includes



Drive Reach



Outside Antenna (311216)



Inside Antenna (314401)



Power Supply (850029)

About

The **Drive Reach** is weBoost's most powerful, in-vehicle cell phone signal booster yet. With its increased uplink output, users get signal up to 2X farther from towers with over twice the signal strength — signifying an increase of almost 5dB in uplink output power.

The sleek, metallic red exterior of the Drive Reach isn't just for show. The unique fin design increases surface area ensuring peak performance. Reliable SMA connections on the booster make secure antenna installation a snap. With its enhanced cellular coverage, enjoy fewer dropped calls, better voice quality, faster data speeds, and extended battery life.

Drive Reach simultaneously boosts cell signal for multiple users. Easy-to-follow instructions make tool-free installation a breeze. Plug the Drive Reach into the car's power supply, place the magnetic roof antenna, and get on the road to better signal.

Drive Reach also has a 2-year manufacturer's warranty and a 30-day money back guarantee.

Specifications

MODEL NUMBER	470154*	
FREQUENCIES	Band 12/17	700 MHz
	Band 13	700 MHz
	Band 5	850 MHz
	Band 4	1700/2100 MHz
	Band 25*/2	1900 MHz
MAX GAIN	50 dB	
IMPEDANCE	50 Ohm	
POWER	12V, 1.8A	
CONNECTORS	SMA Female	
BOOSTER DIMENSIONS	6 x 4.5 x 1.5 in.	
BOOSTER WEIGHT	1.80 lbs.	

*New frequency band utilized by Drive Reach.

Installation

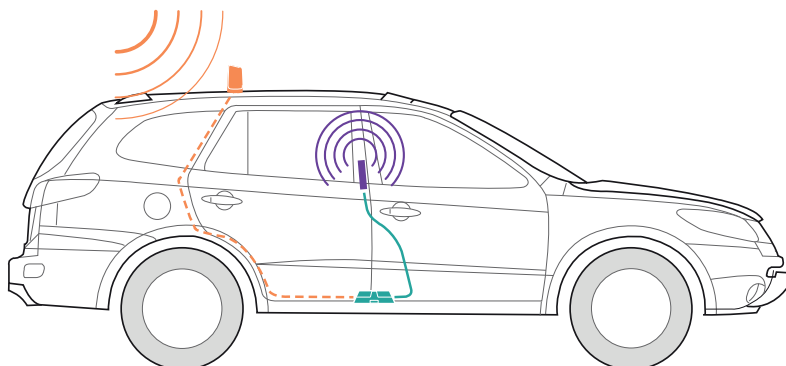

- 1 Receives signal:** The powerful antenna reaches out to access voice and data signals. Then delivers them to the booster.
- 2 Boost signal:** The booster receives the signal, amplifies it, and serves as a relay between your phone and the nearest cell tower.
- 3 Broadcasts signal:** Your devices get a stronger signal, and calls and data are fed through the booster back to the network.

Package Dimensions

4.3 L x 5.6 W x 7.9 H

5.6 in.
x
7.9 in.

FRONT

4.3 in.
x
7.9 in.

SIDE

5.6 in.
x
4.3 in.

TOP/BOTTOM



2.5 lbs.

WEIGHT

MASTER CARTON: **3 PACK** 13.75 L x 9 W x 7 H | 11 lbs.
10 PACK 22 L x 18 W x 8 H | 21.9 lbs.

FOR PARTNER'S USE

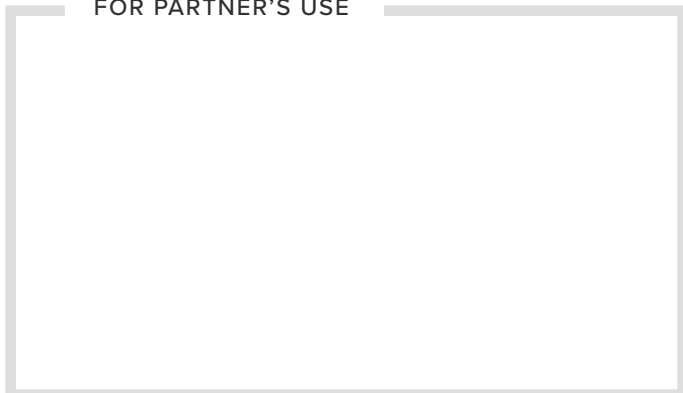

470154_DriveReach_SS_071122

Support



2-Year Warranty from Purchase.

Website: <http://support.weboost.com>

Phone: +1 866 294 1660
Monday to Saturday

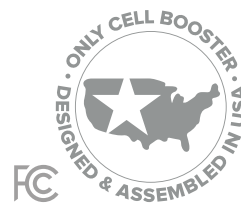

UPC



Drive X

SKU: 475021 MAP: \$429.99

FEATURES

- Boosts cellular signal for multiple users in any passenger vehicle — car, truck, van, or SUV.
- Works on ALL cellular devices with ALL carriers simultaneously.
- Enhances talk, text, and high-speed internet.

⚠️ WARNING: This product can expose you to chemicals including Nickel, which is known to the State of California to cause cancer, and Bisphenol A, which is known to the State of California to cause birth defects or other reproductive harm. For more information go to www.P65Warnings.ca.gov



- BOOSTS SIGNAL ON ALL AVAILABLE NETWORK SPEEDS
- FAST NETWORK SPEEDS
- UP TO +50 dB GAIN
- MULTI-USER WIRELESS BOOSTER

Kit Includes



Drive X



4" Mini Magnet-Mount Antenna (301126)



Slim Low-Profile Antenna (314401)



Power Supply (859913)

About

weBoost's **Drive X** is a powerful, professional-grade in-vehicle cell phone signal booster. Commonly used by first responders throughout the U.S. to boost signals while out on the road with a 60% larger service range than other boosters. The Drive X ensures that you get better voice and data with fewer dropped calls, improved voice quality, faster uploads and downloads, and allows up to 2 hours additional talk time in weak-signal areas. weBoost's Drive X boosts cell signals up to 32X and enhances signals for everyone in the vehicle whether it's a car, truck, or van.

Compatible with all U.S. wireless carriers including Verizon, AT&T, T-Mobile, U.S. Cellular, Straight Talk, and more. All components needed for installation are included as well as simple instructions for a quick, easy setup. Plug the Drive X into the car's power supply, place the magnetic antenna on the center of the roof, and get better wireless signal on the road now. The Drive X comes with a 2-year manufacturer's warranty and a 30-day money back guarantee.

Specifications

MODEL NUMBER	475021†	
FREQUENCIES	Band 12/17	700 MHz
	Band 13	700 MHz
	Band 5	850 MHz
	Band 4	1700/2100 MHz
	Band 2	1900 MHz
MAX GAIN	50 dB	
IMPEDANCE	50 Ohm	
POWER	6V / 2.5A	
CONNECTORS	SMA Female	
BOOSTER DIMENSIONS	6.25 x 4.5 x 1 in.	
BOOSTER WEIGHT	.77 lbs.	

How It Works

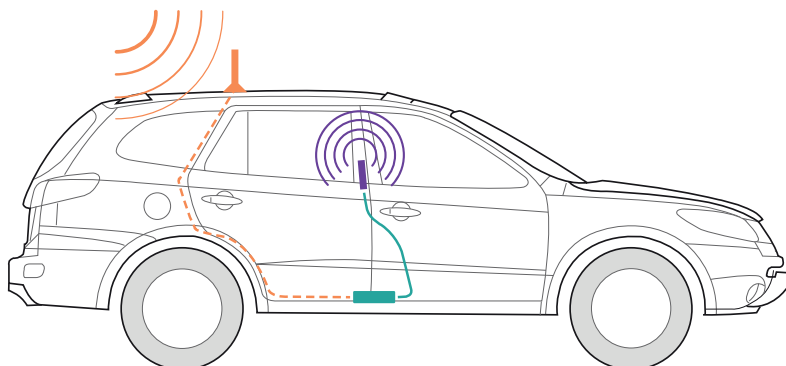

- 1 Outside Antenna:** The outside antenna communicates back and forth with nearby cell towers.
- 2 Booster:** The booster amplifies any cell signal it receives from the outside antenna.
- 3 Inside Antenna:** The inside antenna broadcasts the amplified signal for use throughout the vehicle.

Available Accessories

Optional Antenna Kits



OTR Antenna
Truck Edition
304415*



9.8" Wide Band
Omni-Directional
Marine Antenna
304420*



Drive OTR
Antenna
311229*

Package Dimensions

4 L x 6.25 W x 8 H

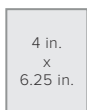

FRONT

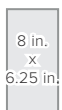

SIDE



TOP/BOTTOM



WEIGHT

MASTER CARTON: 24 L x 18 W x 8 H | 21.7 lbs. | QTY 10

Support



2-Year Warranty from Purchase

Website: <http://support.weboost.com>

Phone: +1 866 294 1660
Monday to Saturday

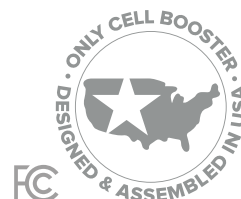

FOR PARTNER'S USE

UPC



475021_DriveX_SS_080922

Drive Sleek

SKU: 470135 MAP: \$199.99

FEATURES

- Enhances all available wireless network signals and speeds throughout a passenger vehicle—car, truck, van, or SUV.
- Single cellular device, cradle signal booster.
- Works with ALL phones and ALL carriers.
- Enhances talk, text, and high-speed internet.

⚠️ WARNING: This product can expose you to chemicals including Nickel, which is known to the State of California to cause cancer, and Bisphenol A, which is known to the State of California to cause birth defects or other reproductive harm. For more information go to www.P65Warnings.ca.gov



- BOOSTS SIGNAL ON ALL AVAILABLE NETWORK SPEEDS
- FAST NETWORK SPEEDS
- UP TO +23 dB GAIN
- SINGLE USER CRADLE BOOSTER

Kit Includes



About

The **Drive Sleek** is weBoost's most versatile vehicle cell phone signal booster. This booster can boost cell signals up to 32x, enhancing data signals for one cellular device used in a car, truck, van or RV - the device held securely in the included cradle. weBoost's Drive Sleek is compatible with all US networks such as Verizon, AT&T, T-Mobile, US Cellular, Straight Talk and more.

This FCC Certified booster comes with all components needed for installation in one package making DIY installation a breeze. Like all weBoost products, the Drive Sleek comes with a 2-year warranty.

Specifications

MODEL NUMBER	470135 ⁺	
FREQUENCIES	Band 12/17	700 MHz
	Band 13	700 MHz
	Band 5	850 MHz
	Band 4	1700/2100 MHz
	Band 2	1900 MHz
MAX GAIN	23 dB	
IMPEDANCE	50 Ohm	
USB PORT POWER	5 V / 2.1 A	
POWER TO BOOSTER	12 V / 1.5 A	
CONNECTORS	SMB	
DIMENSIONS	.65 x 1.60 x 7 in.	
WEIGHT	.55 lbs.	

Installation

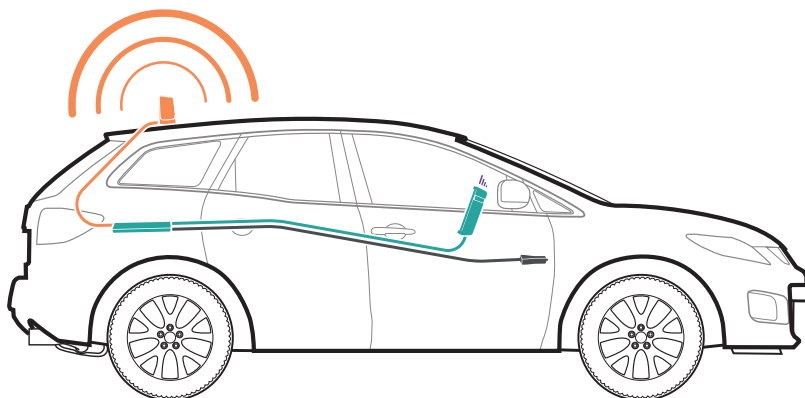

- 1 **Receives signal:** The powerful antenna reaches out to access voice and data signals, and deliver them to the booster.
- 2 **Boost signal:** The booster receives the signal, amplifies it, and serves as a relay between your phone and the nearest cell tower.
- 3 **Broadcasts signal:** Your devices get a stronger signal, and calls and data are fed through the booster back to the network.

Package Dimensions

9.5 L x 8 W x 3 H

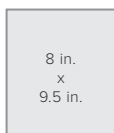

FRONT



SIDE

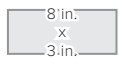

TOP/BOTTOM



WEIGHT

MASTER CARTON: 23 L x 19 W x 14 H | 35 lbs. | QTY 15

FOR PARTNER'S USE

Support

2-Year Warranty from Purchase.

Website: <http://support.weboost.com>

Phone: +1 866 294 1660
Monday to Saturday

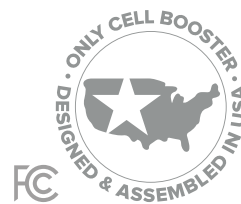

UPC



470135_DriveSleek_SS_110221

Destination RV

SKU: 470159 MAP: \$649.99

FEATURES

- Boosts cell signal in RVs, toy haulers, and trailers when stationary.
- Stops dropped calls, improves streaming, and increases data speeds.
- Supports multiple users and devices simultaneously.
- Works with all phones and cellular devices on all carriers.



- BOOSTS SIGNAL ON ALL AVAILABLE NETWORK SPEEDS
- FASTEST NETWORK SPEEDS
- UP TO +65 dB GAIN
- MULTI-USER WIRELESS BOOSTER

***WARNING:** Cancer and Reproductive Harm - www.P65Warnings.ca.gov.

Kit Includes

Destination RV Booster	Outside Directional Antenna (314445)	Inside Panel Antenna (311239)	30' + 15' (x2) White Low Loss RG6 Coax Cables (950630/YX030-15W)	Flat Window Cable (951177)	F-Female to F-Female Barrel Connector (971129)	AC/DC Power Supply 5V / 4A (850025)	12V DC Fused Hardwire Power Supply (850022)	Telescoping Pole (Up to 25') and Mount Assembly (900203)

About

The weBoost **Destination RV** is our most powerful cell signal booster designed for large RVs, toy haulers, and trailers. For use only when parked, the booster stops dropped calls, improves video streaming, and increases data speeds, especially in remote areas. Every passenger gets strong, reliable signal on all cellular-enabled devices on all carrier networks.

The booster kit includes an outside directional antenna that mounts on a 25-foot telescoping pole to target nearby cell towers. This technology is 5G ready and works on almost any camper or trailer, providing maximum signal inside your RV. The initial DIY installation process takes approximately 30 minutes, and each subsequent takedown and setup takes about 10 minutes.

Like all weBoost boosters, the Destination RV is FCC-approved and comes with a 2-year warranty.

Specifications

MODEL NUMBER	470159*	
FREQUENCIES	Band 12/17	700 MHz
	Band 13	700 MHz
	Band 5	850 MHz
	Band 4	1700/2100 MHz
	Band 25/2	1900 MHz
MAX GAIN	65 dB	
IMPEDANCE	75 Ohm	
POWER	4.5V DC	
CONNECTORS	F Female	
BOOSTER DIMENSIONS	6 x 6 x 1.6 in.	
BOOSTER WEIGHT	1.9 lbs.	

Installation

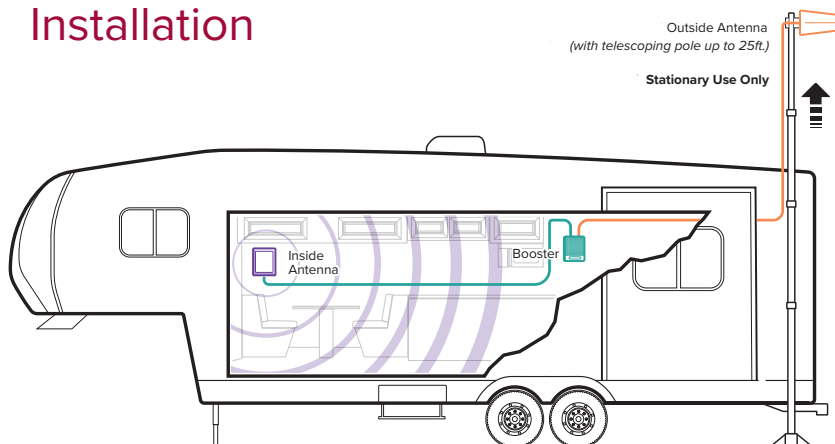

- 1 **Receives signal:** The powerful antenna reaches out to access existing outside signal from nearby cell towers and delivers it to the booster.
- 2 **Boost signal:** The booster received the signal, amplifies it inside your RV, and serves as a relay between cellular devices and the nearest cell tower.
- 3 **Broadcasts signal:** Your devices get a stronger signal, and calls and data are fed through the booster back to the network.

Package Dimensions

Combo Box: 9.125 in L x 9.125 in W x 76 in H

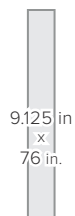

FRONT



SIDE

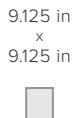

TOP/ BOTTOM



WEIGHT

Support



2-Year Warranty from Purchase.

Website: <http://support.weboost.com>

Phone: +1 866 294 1660
Monday to Saturday

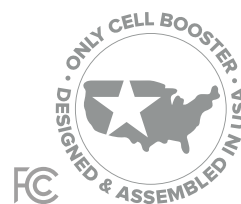

FOR PARTNER'S USE

UPC



470159_destinationrv_SS_032222

Drive Reach RV

SKU: 470354 MAP: \$519.99

FEATURES

- Modular antenna design for optimal positioning on RVs.
- Outside antenna fits universal CB mounts (3/8-24 thread).
- Spring base protects antenna from wind and low branches.
- Works with ALL phones and cellular devices on ALL carriers.
- Boosts cell signal in RVs when parked or while in motion.

⚠️ WARNING: This product can expose you to chemicals including Nickel, which is known to the State of California to cause cancer, and Bisphenol A, which is known to the State of California to cause birth defects or other reproductive harm. For more information go to www.P65Warnings.ca.gov



- BOOSTS SIGNAL ON ALL AVAILABLE NETWORK SPEEDS
- FAST NETWORK SPEEDS
- UP TO +50 dB GAIN
- MULTI-USER WIRELESS BOOSTER

Kit Includes

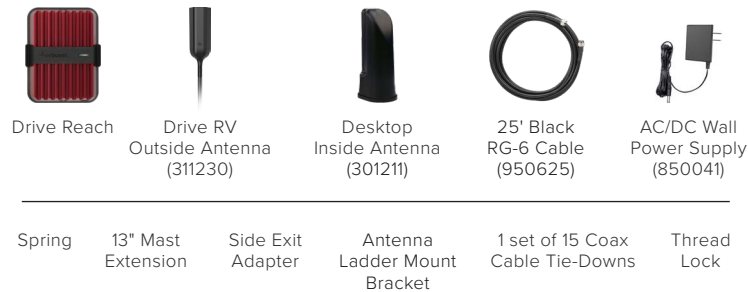

About

The **Drive Reach RV** is a versatile, multi-user, in-vehicle cell signal booster—designed for use with all RV classes and towable trailers. Backed by up to 50 dB max gain, the Drive Reach RV delivers the strongest cell signal possible on all available network speeds. The enhanced outside antenna's modular design allows for custom setup and optimal positioning for signal reception. Whether parked or on the road, Drive Reach RV users experience fewer dropped calls, better voice quality, uninterrupted texts, faster data speeds, better streaming, and improved hotspot capability.

The Drive Reach RV kit comes with everything for DIY installation; including 25' of RG-6 extender cable for ideal booster placement within RVs of any size. With side-exit adapter and mounting hardware, the outside antenna fits universal CB-antenna mounts and exterior RV ladder poles. Drive Reach RV is compatible with all cell phones, hotspots, cellular-connected tablets, and other cell devices on all US mobile carriers—including Verizon, AT&T, and T-Mobile.

Like all weBoost boosters, the Drive Reach RV is FCC-approved and comes with a 2-year warranty.

Specifications

MODEL NUMBER	470354 ⁺	
FREQUENCIES	Band 12/17	700 MHz
	Band 13	700 MHz
	Band 5	850 MHz
	Band 4	1700/2100 MHz
	Band 25/2 [*]	1900 MHz
MAX GAIN	50 dB	
IMPEDANCE	50 Ohm	
POWER	12V, 1.8A	
CONNECTORS	SMA Female	
BOOSTER DIMENSIONS	6 x 4.5 x 1.5 in.	
BOOSTER WEIGHT	1.8 lbs	

^{*}New frequency band utilized by Drive Reach RV

Installation

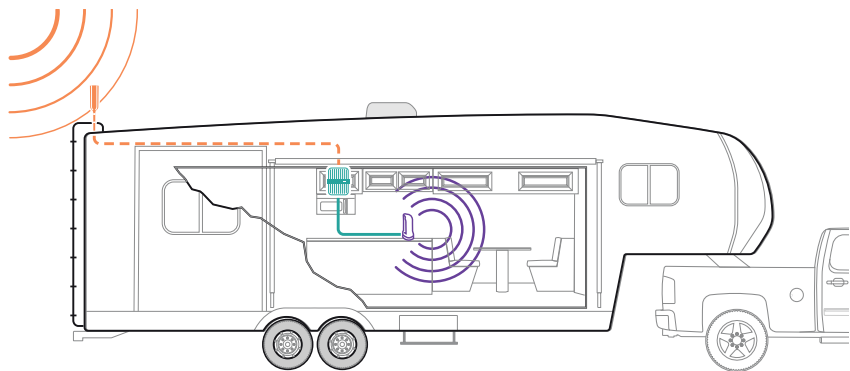

- 1 Receives signal:** The powerful antenna reaches out to access a voice and data signal, and delivers it to the booster.
- 2 Boost signal:** The booster receives the signal, amplifies it, and serves as a relay between your phone and the nearest cell tower.
- 3 Broadcasts signal:** Your devices get a stronger signal, and calls and data are fed through the booster back to the network.

Package Dimensions

21 L x 11.5 W x 3.75 H

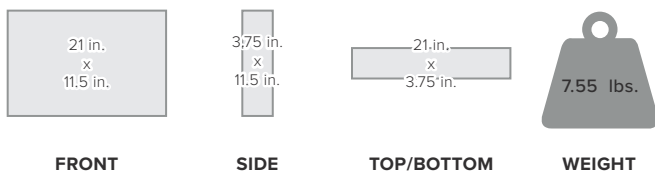

MASTER CARTON: 23 L x 19 W x 13 H | 41 lbs. | QTY 5

FOR PARTNER'S USE

Support



2-Year Warranty from Purchase.

Website: <http://support.weboost.com>

Phone: +1 866 294 1660
Monday to Saturday

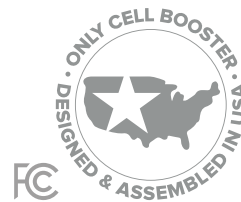

UPC

DRIVE REACH RV



8 10005 96131 8

470354_Drive-REACH-RV_SS_122921

Drive X RV

SKU: 471410 MAP: \$449.99

FEATURES

- Modular antenna design for optimal positioning on RVs.
- Outside antenna fits universal CB mounts (3/8-24 thread).
- Spring base protects antenna from wind and low branches.
- Works with ALL phones and cellular devices on ALL carriers.
- Boosts cell signal in RVs when parked or while in motion.

⚠️ WARNING: This product can expose you to chemicals including Nickel, which is known to the State of California to cause cancer, and Bisphenol A, which is known to the State of California to cause birth defects or other reproductive harm. For more information go to www.P65Warnings.ca.gov



- BOOSTS SIGNAL ON ALL AVAILABLE NETWORK SPEEDS
- UP TO +50 dB GAIN
- MULTI-USER WIRELESS BOOSTER

Kit Includes



About

The **Drive X RV** is a versatile, multi-user, in-vehicle cell signal booster—designed for use with all RV classes and towable trailers. Backed by up to 50 dB max gain, the Drive X RV delivers the strongest cell signal possible on all available network speeds. The enhanced outside antenna’s modular design allows for custom setup and optimal positioning for signal reception. Whether parked or on the road, Drive X RV users experience fewer dropped calls, better voice quality, uninterrupted texts, faster data speeds, better streaming, and improved hotspot capability.

The Drive X RV kit comes with everything for DIY installation, including 25’ of RG-6 extender cable for ideal booster placement within RVs of any size. With side-exit adapter and mounting hardware, the outside antenna fits universal CB-antenna mounts and exterior RV ladder poles. Drive X RV is compatible with all cell phones, hotspots, cellular-connected tablets, and other cell devices on all U.S. mobile carriers—including Verizon, AT&T, and T-Mobile.

Like all weBoost boosters, the Drive X RV is FCC-approved and comes with a 2-year warranty.

Specifications

MODEL NUMBER	471410 ⁺	
FREQUENCIES	Band 12/17	700 MHz
	Band 13	700 MHz
	Band 5	850 MHz
	Band 4	1700/2100 MHz
	Band 2	1900 MHz
MAX GAIN	50 dB	
IMPEDANCE	50 Ohm	
POWER	12VDC	
CONNECTORS	SMA Female	
BOOSTER DIMENSIONS	6.25 x 4.25 x 1 in	
BOOSTER WEIGHT	.8 lbs	

How It Works

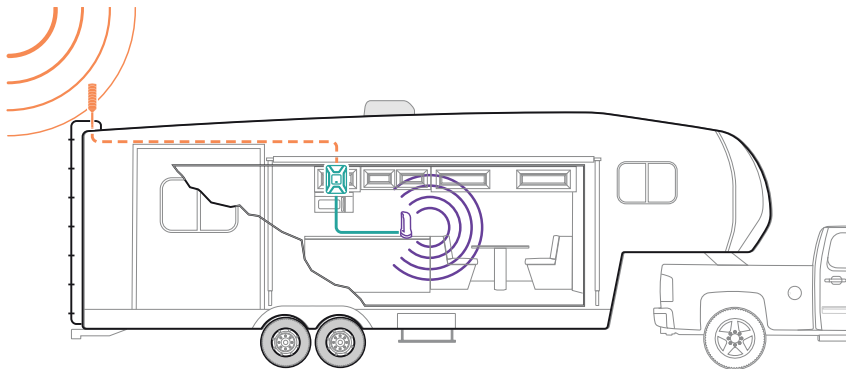

- 1 Outside Antenna:** The outside antenna communicates back and forth with nearby cell towers.
- 2 Booster:** The booster amplifies any cell signal it receives from the outside antenna.
- 3 Inside Antenna:** The inside antenna broadcasts the amplified signal for use throughout the vehicle.

Package Dimensions

10.75 L x 3.75 W x 22 H

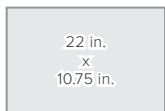

FRONT



SIDE

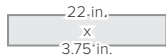

TOP/BOTTOM



WEIGHT

MASTER CARTON: 22.5 L x 19 W x 13 H | 38.8 lbs. | QTY 5

FOR PARTNER'S USE

Support



2-Year Warranty from Purchase

Website: <http://support.weboost.com>

Phone: +1 866 294 1660
Monday to Saturday

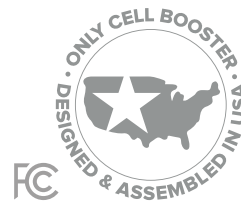

UPC



471410_Drive-X-RV_SS_080922

Drive Reach OTR

SKU: 477154 MAP: \$519.99

FEATURES

- Boosts signal for trucks with the OTR Trucker Antenna.
- Modular, height-adjustable antenna, from 7.5 to 40 inches so it can be installed on any vehicle.
- For multiple devices and users.
- Works on ALL cellular devices with ALL carriers simultaneously.
- Enhances talk, text, and high-speed data internet.

⚠️ WARNING: This product can expose you to chemicals including Nickel, which is known to the State of California to cause cancer, and Bisphenol A, which is known to the State of California to cause birth defects or other reproductive harm. For more information go to www.P65Warnings.ca.gov



- BOOSTS SIGNAL ON ALL AVAILABLE NETWORK SPEEDS
- FAST NETWORK SPEEDS
- UP TO +50 dB GAIN
- MULTI-USER WIRELESS BOOSTER

Kit Includes

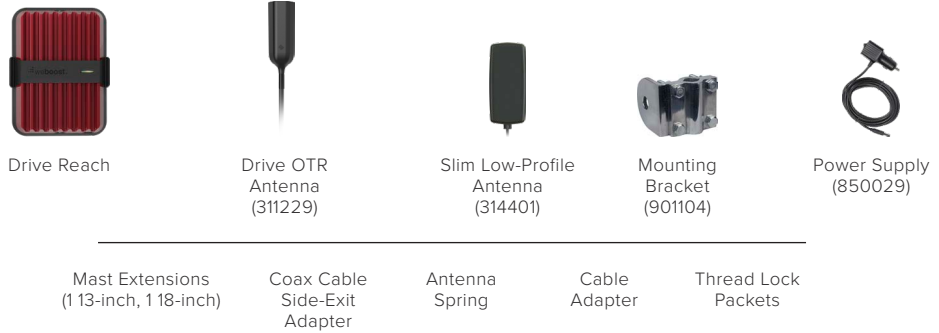

About

The **Drive Reach OTR** is our most powerful in-vehicle truck cell phone signal booster certified in the US, with Wilson Electronics* ruggedized, all weather OTR Truck Omni-Directional Antenna for maximum connection range and a 60% larger service range than the other boosters out there. The Drive Reach OTR boosts voice and data with max FCC-allowed 50 dB system gain, enhancing all available network signals, up to 32x. Drivers get fewer lost connections and dead zones, better audio quality, faster data uploads and downloads with this premier signal booster.

As with all weBoost boosters, all components needed for installation come in one package for easy DIY installation. The power supply plugs into CLA, while ignition power kits are also available. The Drive Reach OTR works with all cellular devices and all US carriers. The booster kit comes with parts to accommodate multiple installation options. Included are 2 mast extensions, 3-way antenna mount, side exit adapter, antenna spring, cable adapter, and thread lock packets.

All boosters come with a 2-year warranty.

Specifications

MODEL NUMBER	477154†	
FREQUENCIES	Band 12/17	700 MHz
	Band 13	700 MHz
	Band 5	850 MHz
	Band 4	1700/2100 MHz
	Band 25/2*	1900 MHz
MAX GAIN	50 dB	
IMPEDANCE	50 Ohm	
POWER	12V 1.8A	
CONNECTORS	SMA Female	
BOOSTER DIMENSIONS	6 x 4.5 x 1.5 in.	
BOOSTER WEIGHT	1.8 lbs.	

*New frequency band utilized by Drive Reach OTR

Installation

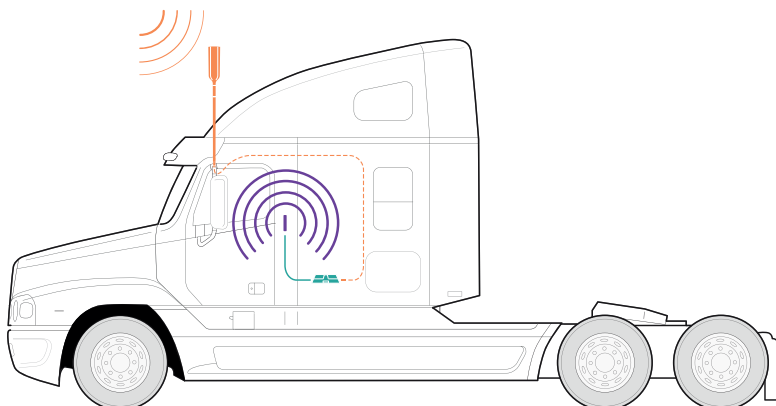

- 1 **Outside Antenna:** The outside antenna communicates back and forth with nearby cell towers.
- 2 **Booster:** The booster amplifies any cell signal it receives from the outside antenna.
- 3 **Inside Antenna:** The inside antenna broadcasts the amplified signal for use throughout the vehicle.

Available Accessories

Optional Antenna Kits



9.8" Wide Band
Omni-Directional
Marine Antenna
304420*



4" Mini Magnet
Mount Antenna
301126*

Package Dimensions

21 L x 11.5 W x 3.75 H

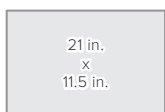

FRONT



SIDE

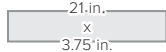

TOP/BOTTOM



WEIGHT

MASTER CARTON: 23 x 19 x 13 | 35.9 Lbs. | QTY 5

Support



2-Year Warranty from Purchase.

Website: <http://support.weboost.com>

Phone: +1 866 294 1660
Monday to Saturday

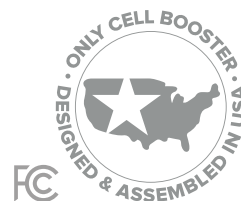

FOR PARTNER'S USE

UPC

DRIVE REACH OTR



8 10005 96301 5

477154_DRIVE REACH OTR_SS_122921

Drive Sleek OTR

SKU: 470235 MAP: \$279.99

FEATURES

- Boosts data for large trucks and RV's with OTR Antenna.
- Single cellular device, cradle signal booster.
- Works with ALL phones and ALL carriers.
- Enhances talk, text, and high-speed data internet.

†⚠️WARNING: This product can expose you to chemicals including Nickel, which is known to the State of California to cause cancer, and Bisphenol A, which is known to the State of California to cause birth defects or other reproductive harm. For more information go to www.P65Warnings.ca.gov



- BOOSTS SIGNAL ON ALL AVAILABLE NETWORK SPEEDS
- FAST NETWORK SPEEDS
- UP TO +23 dB GAIN
- SINGLE USER CRADLE BOOSTER

Kit Includes

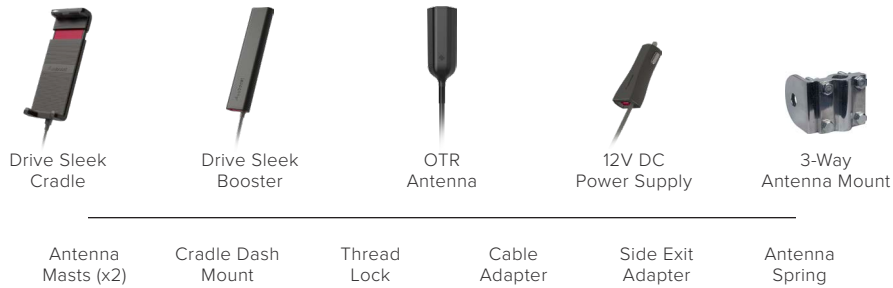

About

The weBoost **Drive Sleek OTR** cellular signal booster improves voice and 4G/LTE and 3G data speeds inside your semi-truck, wherever the road takes you.

Designed specifically for today's connected truck driver, this kit combines the popular Drive Sleek cradle booster along with our best-performing OTR Antenna in a versatile, cost-effective communications solution.

This cellular signal booster delivers the maximum signal gain allowed by the FCC for cellular cradle boosters and comes with all components needed in one package, making DIY installation a breeze. Like all weBoost products, the Drive Sleek OTR comes with a 2-year warranty.

Specifications

MODEL NUMBER	470235†	
FREQUENCIES	Band 12/17	700 MHz
	Band 13	700 MHz
	Band 5	850 MHz
	Band 4	1700/2100 MHz
	Band 2	1900 MHz
MAX GAIN	23 dB	
IMPEDANCE	50 Ohm	
USB PORT POWER	5 V, 2.1 A	
POWER TO BOOSTER	12 V / 1.5 A	
CONNECTORS	SMA	
DIMENSIONS	.65 x 1.60 x 7 in.	
WEIGHT	.55 lbs.	

Installation

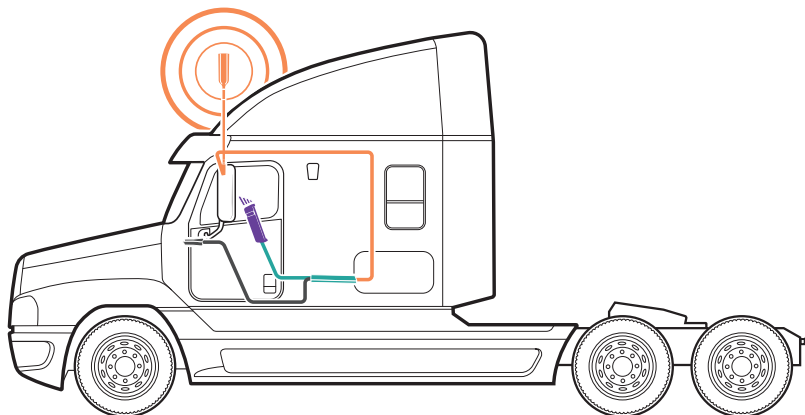

- 1 Receives signal:** The powerful antenna reaches out to access voice and data signals, and deliver them to the booster.
- 2 Boost signal:** The booster receives the signal, amplifies it, and serves as a relay between your phone and the nearest cell tower.
- 3 Broadcasts signal:** Your devices get a stronger signal, and calls and data are fed through the booster back to the network.

Available Accessories

Optional Antenna Kits

Not available accessories at this time.

Package Dimensions

21.75 L x 12.25 W x 3.50 H



FRONT



SIDE

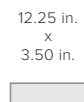

TOP/BOTTOM



WEIGHT

MASTER CARTON: 22.5 L x 19 W x 13.5 H | 29.870 lbs. | QTY 5

FOR PARTNER'S USE

Support

2-Year Warranty from Purchase.

Website: <http://support.weboost.com>

Phone: +1 866 294 1660
Monday to Saturday

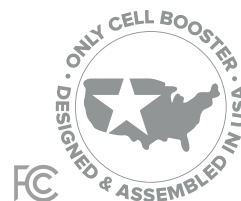

UPC



470235_DriveSleekOTR_SS_Rev01_011222

Drive X OTR

SKU: 470210 MAP: \$399.99

FEATURES

- Boosts data signal for large trucks and RVs with the Drive OTR Antenna.
- For multiple devices and users.
- Works on ALL cellular devices with ALL carriers simultaneously.
- Enhances talk, text, and high-speed data internet.

† **WARNING:** This product can expose you to chemicals including Nickel, which is known to the State of California to cause cancer, and Bisphenol A, which is known to the State of California to cause birth defects or other reproductive harm. For more information go to www.P65Warnings.ca.gov



- BOOSTS SIGNAL ON ALL AVAILABLE NETWORK SPEEDS
- FAST NETWORK SPEEDS
- UP TO +50 dB GAIN
- MULTI-USER WIRELESS BOOSTER

Kit Includes



Drive X



Drive OTR Antenna (311229)



Slim Low-Profile Antenna (314401)



Mounting Bracket (901104)



Power Supply (859913)

Mast Extensions (x2)

Coax Cable Side-Exit Adapter

Antenna Spring

Cable Adapter

Thread Lock Packets

About

The **Drive X OTR** is our most powerful in-vehicle truck cell phone signal booster certified in the US, with Wilson Electronics* ruggedized, all weather OTR Truck Omni-Directional Antenna for maximum connection range and a 60% larger service range than the other boosters out there. The Drive X OTR boosts voice and data with max FCC-allowed 50 dB system gain, enhancing 4G LTE, as well as 3G and 2G network signals, up to 32x. Drivers get fewer lost connections and dead zones, better audio quality, faster data uploads and downloads with this premier signal booster. As with all weBoost boosters, all components needed for installation come in one package for easy DIY installation. The power supply plugs into CLA, while ignition power kits are also available. The Drive X OTR works with all cellular devices and all U.S. carriers. The booster kit comes with parts to accommodate multiple installation options. Included are 2 mast extensions, 3-way antenna mount, side exit adapter, antenna spring, cable adapter, and thread lock packets.

All boosters come with a 2-year warranty.

Specifications

MODEL NUMBER	470210†	
FREQUENCIES	Band 12/17	700 MHz
	Band 13	700 MHz
	Band 5	850 MHz
	Band 4	1700/2100 MHz
	Band 2	1900 MHz
MAX GAIN	50 dB	
IMPEDANCE	50 Ohm	
POWER	6V / 2.5A	
CONNECTORS	SMA Female	
BOOSTER DIMENSIONS	6.25 x 4.5 x 1 in.	
BOOSTER WEIGHT	.77 lbs.	

Installation

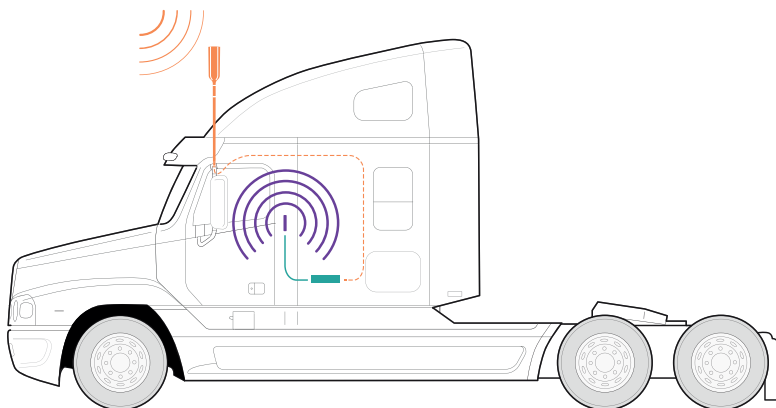

- 1 **Receives signal:** The powerful antenna reaches out to access voice and data signals, and deliver them to the booster.
- 2 **Boost signal:** The booster receives the signal, amplifies it, and serves as a relay between your phone and the nearest cell tower.
- 3 **Broadcasts signal:** Your devices get a stronger signal, and calls and data are fed through the booster back to the network.

Available Accessories

Optional Antenna Kits



9.8" Wide Band
Omni-Directional
Marine Antenna
304420*



4" Mini Magnet
Mount Antenna
301126*

Package Dimensions

21.75 L x 1.50 W x 3.50 H

1.50 in.
x
3.50 in.

FRONT

21.75 in.
x
3.50 in.

SIDE

1.50 in.
x
21.75 in.

TOP/BOTTOM



4.968 lbs.

WEIGHT

MASTER CARTON: 22.50 x 19.00 x 13.5 | 30.780 Lbs. | QTY 5

Support



2-Year Warranty from Purchase.

Website: <http://support.weboost.com>

Phone: +1 866 294 1660
Monday to Saturday

*⚠️ **WARNING:** Cancer and Reproductive Harm - www.P65Warnings.ca.gov.

UPC



470210_Drive4G-X-OTR_SS_061521

FOR PARTNER'S USE





Drive Reach Overland

SKU: 472061 MAP: \$549.99

FEATURES

- Maximizes cell signal for overland and off-road vehicles.
- Comes with an expertly engineered, versatile mounting bracket that can attach to the vehicle using a T-slot, pole, or fixed mounting.
- Offers an adjustable outside antenna that can be easily folded down for garage storage.
- Designed for multiple devices and users.
- Works on ALL cellular devices and ALL carriers simultaneously.
- Enhances talk, text, and high-speed data internet while off-roading.



- 
MOUNTS TO YOUR VEHICLE IN MULTIPLE WAYS.
- 
ANTENNA FOLDS DOWN FOR EASY STORAGE.
- 
BOOSTS SIGNAL ON ALL AVAILABLE NETWORK SPEEDS.
- 
MULTI-USER WIRELESS BOOSTER.

⚠️ WARNING: This product can expose you to chemicals including Nickel, which is known to the State of California to cause cancer, and Bisphenol A, which is known to the State of California to cause birth defects or other reproductive harm. For more information go to www.P65Warnings.ca.gov

Kit Includes



Drive Reach 12V Amp



Overland Antenna (311248)



13-inch Mast Extension



Overland Mount (901168)



Inside Antenna (314401)



CLA Power Supply (850029)

LMR-195 Cable (951114)

Coax Cable Side Exit Adapter

Antenna Spring

Thread Lock Packets

About

The **Drive Reach Overland** is our newest in-vehicle cell phone signal booster, specially designed for overland and off-road vehicles. The Drive Reach Overland sports a durable, all-weather omni antenna, providing maximum connectivity for when off the beaten path. Overlanding enthusiasts will appreciate the versatile mounting hardware – enabling them to attach the outside antenna in multiple ways. The outside antenna can also be folded down for when a vehicle is stored inside.

The Drive Reach Overland enhances all available network signals up to 32x. Drivers experience fewer lost connections and dead zones, better audio quality, and faster data uploads and downloads with this new signal booster. All components needed for installation come in one package. The Drive Reach Overland works with all cellular devices and all US carriers.

The Drive Reach Overland booster comes with a 2-year warranty.

Specifications

MODEL NUMBER	472061†	
FREQUENCIES	Band 12/17	700 MHz
	Band 13	700 MHz
	Band 5	850 MHz
	Band 4	1700/2100 MHz
	Band 25/2	1900 MHz
MAX GAIN	50 dB	
IMPEDANCE	50 Ohm	
POWER	12V 1.8A	
CONNECTORS	SMA M and SMA F	
BOOSTER DIMENSIONS	6 x 4.5 x 1.5 in.	
BOOSTER WEIGHT	1.8 lbs.	

Installation

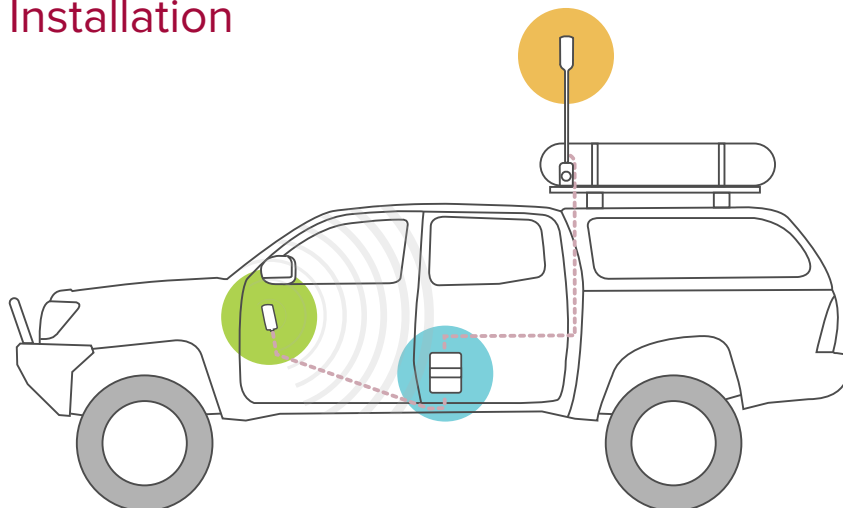

- 1 Outside Antenna:** The outside antenna communicates back and forth with nearby cell towers.
- 2 Booster:** The booster amplifies any cell signal it receives from the outside antenna.
- 3 Inside Antenna:** The inside antenna broadcasts the amplified signal for use throughout the vehicle.

Available Accessories

Buyers can purchase accessories for additional customization.



18-foot
LMR-195 Cable
952315



Desktop
Antenna
311160



18-inch Mast
Extension
991129



Hardwire
Power Supply
950079

Package Dimensions

20.75 L x 11.5 W x 3.75 H



FRONT



SIDE

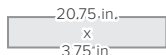

TOP/BOTTOM



WEIGHT

MASTER CARTON: 23 x 19 x 13 | 35.9 Lbs. | QTY 5

Support



2-Year Warranty from Purchase.

Website: <http://support.weboost.com>

Phone: +1 866 294 1660
Monday to Saturday

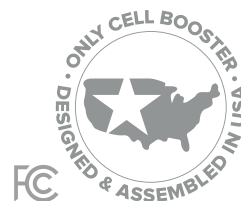

FOR PARTNER'S USE

UPC

DRIVE REACH OVERLAND



8 10005 96398 5

472061_DRIVE REACH OVERLAND_SS_112922



weBoost for Business

Product Line Up

weBoost Mobile Boosters

IN-BUILDING BOOSTERS

MOBILE BOOSTERS



**weBoost
Installed |
Office 200**
473047

\$3,799.99



**weBoost
Office 200**
472047
471047

\$1,699.99



**weBoost
Office 100**
472060
473060

\$1,299.99



**Drive Reach
Fleet**
470254

\$524.99



**Drive X
Fleet**
473021

\$424.99



**Drive Reach
OTR Fleet**
471254

\$549.99



**Drive Reach
Flex Fleet**
478061

\$549.99

COMPATIBILITY

Boosts signal on all available network speeds

Most Powerful

✓

✓

MULTIPLE
USERS

✓

✓

✓

✓

✓

✓

✓

UPC

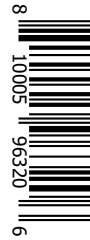
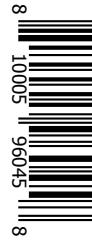

⚠ See the individual product pages for applicable Prop 65 Warnings.

Product Line Up

weBoost Mobile Boosters

IN-BUILDING BOOSTERS

MOBILE BOOSTERS



**weBoost
Installed | Office
200**
473047

\$3,799.99



**weBoost
Office 200**
472047
471047

\$1,699.99



**weBoost
Office 100**
472060
473060

\$1,299.99



**Drive Reach
Fleet**
470254

\$524.99



**Drive X
Fleet**
473021

\$424.99



**Drive Reach OTR
Fleet**
471254

\$549.99



**Drive Reach
Flex Fleet**
478061

\$549.99

EXTERNAL ANTENNA	Outside Omni Plus 314423	Outside Omni Plus 314422 / 314423	Outside Omni Plus 314422 / 314423	NMO Antenna 314405	NMO Antenna 314405	OTR Antenna 311229	NMO Antenna 314405	
INTERNAL ANTENNA	2x Low Profile Dome 314407	Low Profile Dome Antenna 314407	Inside Dome Antenna 304412	Slim Low-Profile Antenna 314401	Slim Low-Profile Antenna 314401	Slim Low-Profile Antenna 314401	In-Vehicle Antenna 314401	
FREQUENCIES MHZ	Band 12/17 700 Band 13 700 Band 5 850 Band 4 1700/2100 Band 25/2 1900	Band 12/17 700 Band 13 700 Band 5 850 Band 4 1700/2100 Band 2 1900	Band 12/17 700 Band 13 700 Band 5 850 Band 4 1700/2100 Band 2 1900	Band 12/17 700 Band 13 700 Band 5 850 Band 4 1700/2100 Band 25/2 1900	Band 12/17 700 Band 13 700 Band 5 850 Band 4 1700/2100 Band 25/2 1900	Band 12/17 700 Band 13 700 Band 5 850 Band 4 1700/2100 Band 2 1900	Band 12/17 700 Band 13 700 Band 5 850 Band 4 1700/2100 Band 2 1900	Band 12/17 700 Band 13 700 Band 5 850 Band 4 1700/2100 Band 25/2 1900
MAX GAIN	72 dB	72 dB	72 dB	50 dB	50 dB	50 dB	50 dB	
IMPEDANCE	75 Ohm	50/75 Ohm	50/75 Ohm	50 Ohm	50 Ohm	50 Ohm	50 Ohm	
POWER	110-240V AC, 50-60 Hz, 20 W	110-240V AC, 50-60 Hz, 20 W	110-240V AC, 50-60 Hz, 20 W	12V 1.8A	6V/ 2.5A	12V 1.8A	12V 1.8A	
CONNECTORS	F-Female	N-Female / F-Female	N-Female / F-Female	SMA Male	SMA	SMA Male	SMA	
BOOSTER DIMENSIONS	14.25 x 10.75 x 2.25 in	14.25 x 10.75 x 2.25 in	6 x 6 x 1.8 in	6 x 4.5 x 1.5 in.	6.25 x 4.5 x 1 in.	6 x 4.5 x 1.5 in.	6 x 4.5 x 1.5 in.	
BOOSTER WEIGHT	7.7 lbs	7.7 lbs	1.9 lbs	1.80 lbs.	.77 lbs.	1.80 lbs.	1.80 lbs.	

UPC

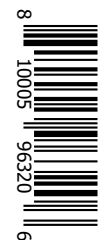
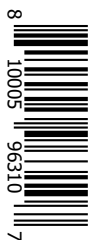
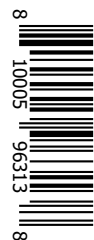
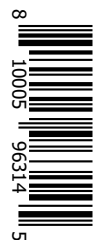

FOR PARTNER'S USE

Website: <http://support.weboost.com>

Phone: +1 866 294 1660
Monday to Saturday

⚠ See the individual product pages for applicable Prop 65 Warnings.

weBoost Installed | Office 200

SKU: 473047 MAP: \$3,799.99

FEATURES

- Best-in-class amplifier system for small-to-medium businesses and warehouses
- Covers 15,000 to 35,000 square feet
- Includes professional installation anywhere in the US
- Comes with 2 inside antennas for more complete coverage
- Is FCC approved and works on all U.S. carrier networks, including Verizon, AT&T, T-Mobile, UScellular, and more



About

Resolve cell signal issues with a quick, turnkey solution that includes complete, professional installation. **The weBoost | Installed Office 200** is our best-in-class amplifier solution, designed for small-to-medium businesses and warehouses. It comes with two low-profile antennas for optimal cell signal coverage throughout a commercial space. weBoost Installed | Office 200 is 5G compatible and improves cell signal on all U.S. carrier networks, including Verizon, AT&T, T-Mobile, UScellular and others. weBoost Installed | Office 200 also comes with an industry-leading 3-year manufacturer's warranty and a 30-day money-back guarantee.

Kit Includes

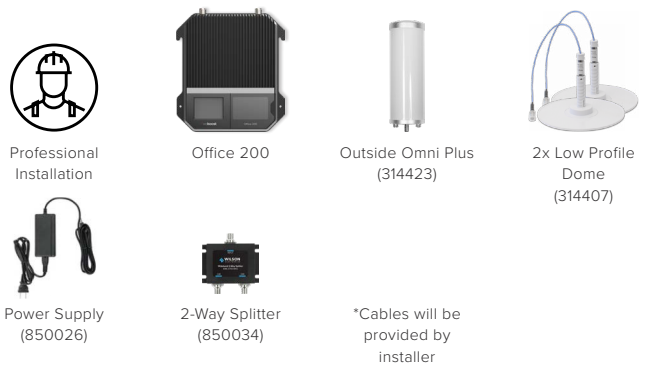

Specifications

SKU NUMBER	473047 [†]	
FREQUENCIES	Band 12/17	700 MHz
	Band 13	700 MHz
	Band 5	850 MHz
	Band 4	1700/2100 MHz
	Band 25/2	1900 MHz
MAX GAIN	72 dB	
IMPEDANCE	75 Ohm	
POWER	110-240V AC, 50-60 Hz, 20 W	
CONNECTORS	F-Female	
BOOSTER DIMENSIONS	14.25 x 10.75 x 2.25 in	
BOOSTER WEIGHT	7.7 lbs	

[†] **WARNING:** This product can expose you to chemicals including Nickel, which is known to the State of California to cause cancer, and Bisphenol A, which is known to the State of California to cause birth defects or other reproductive harm. For more information go to www.P65Warnings.ca.gov

How It Works

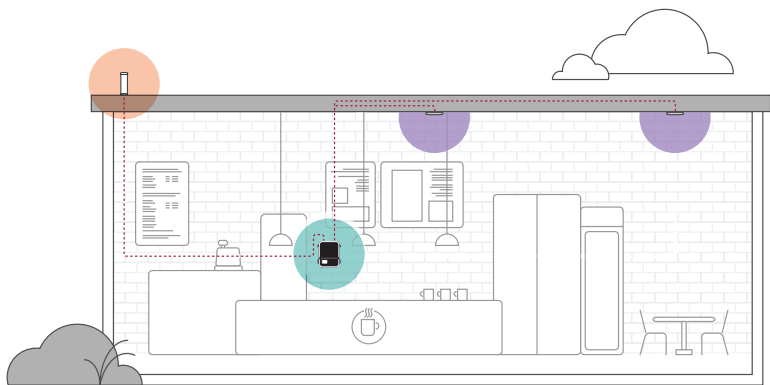

- 1 Outside antenna:** The outside antenna communicates back and forth with nearby cell towers.
- 2 Booster:** The booster amplifies any cell signals it receives from the outside antenna.
- 3 Inside antennas:** The inside antennas broadcast these signals for use throughout your business.

Package Dimensions (Approx.)

20 L x 16 W x 14 H



FRONT



SIDE

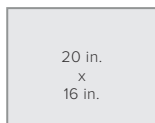

TOP/BOTTOM



WEIGHT

MASTER CARTON: 20 L x 16 W x 14 H | 15.2 Lbs. | Qty 1

FOR PARTNER'S USE

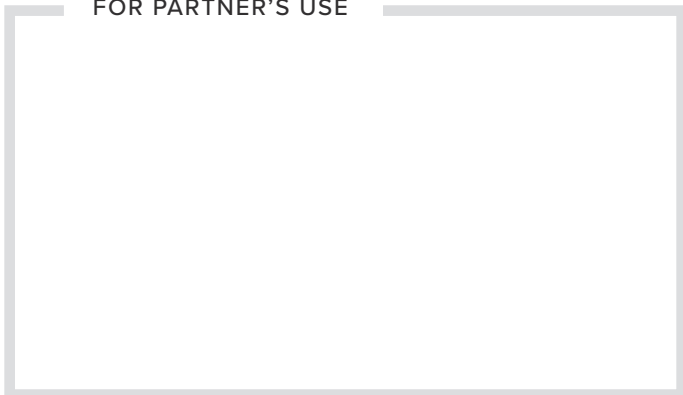

473047_weBoost Installed | Office 200_SS_062321

Support



3-Year Warranty from Purchase.

Website: <http://support.weboost.com>

Phone: +1 866 294 1660
Monday to Saturday

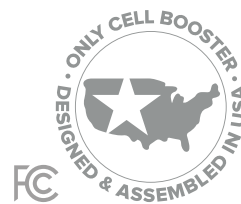

UPC



Office 200

SKU: 50 Ohm: 472047 **MAP:** \$1,699.99
 75 Ohm: 471047

FEATURES

- Ideal amplifier system for small-to-medium businesses
- Covers 12,000 to 35,000 square feet
- Comes with LCD touch screen for increased usability
- Allows manual control of frequency bands
- Is FCC approved and works on all U.S. carrier networks, including Verizon, AT&T, T-Mobile, UScellular, and more



Kit Includes

472047 50 Ohm Kit	Office 200 Amplifier	Omni Plus Antenna 314422	Low Profile Dome Antenna 314407	Lightning Surge Protector 859902	2ft Low-Loss Wilson400 Cable 952302	60ft Low-Loss Wilson400 Cable 952360	75ft Low-Loss Wilson400 Cable 952375
471047 75 Ohm Kit	Office 200 Amplifier	Omni Plus Antenna 314423	Low Profile Dome Antenna 314407	Lightning Surge Protector 859992	2ft Low-Loss RG11 Cable 951127	60ft Low-Loss RG11 Cable 951160	75ft Low-Loss RG11 Cable 951175

About

weBoost **Office 200** is perfect for small to medium-sized businesses and warehouses looking for a high-performance amplifier solution to improve cell signal in a commercial space. Office 200 comes with a color LCD touch screen, allowing users to troubleshoot, assess performance, adjust the outside antenna, and turn bands on and off. All components needed for do-it-yourself installation are included. Office 200 is 5G compatible and improves cell signal on all U.S. carrier networks, including Verizon, AT&T, T-Mobile, UScellular and more. Office 200 comes with an industry-leading 3-year manufacturer's warranty and a 30-day money-back guarantee.

Specifications

SKU NUMBER	472047+ / 471047+	
FREQUENCIES	Band 12/17	700 MHz
	Band 13	700 MHz
	Band 5	850 MHz
	Band 4	1700/2100 MHz
	Band 25/2	1900 MHz
MAX GAIN	72 dB	
IMPEDANCE	50 Ohm / 75 Ohm	
POWER	110-240V AC, 50-60 Hz, 20 W	
CONNECTORS	N-Female / F-Female	
BOOSTER DIMENSIONS	14.25 x 10.75 x 2.25 in	
BOOSTER WEIGHT	7.7 lbs	

⚠️ WARNING: This product can expose you to chemicals including Nickel, which is known to the State of California to cause cancer, and Bisphenol A, which is known to the State of California to cause birth defects or other reproductive harm. For more information go to www.P65Warnings.ca.gov

How It Works

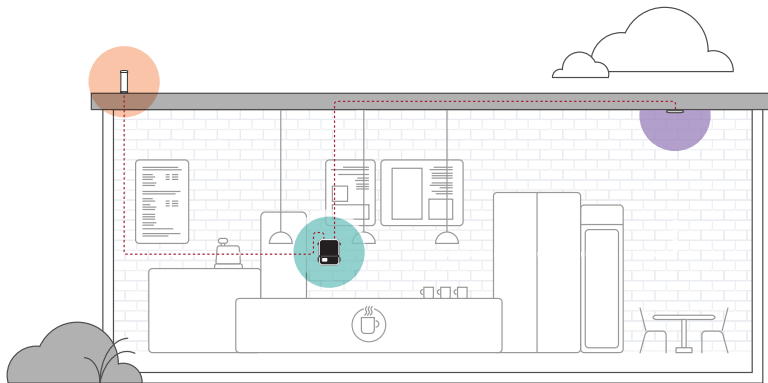

- 1 Outside antenna:** The outside antenna communicates back and forth with nearby cell towers.
- 2 Booster:** The booster amplifies any cell signals it receives from the outside antenna.
- 3 Inside antenna:** The inside antenna broadcasts these signals for use throughout your business.

Specifications

Power output for single cell phone (Uplink) dBm	700 MHz Band 12/17	700 MHz Band 13	800 MHz Band 5	1700 MHz Band 4	1900 MHz Band 2/25
	24.0	24.0	25.0	25.0	25.0
Power output for single cell phone (Downlink) dBm	700 MHz Band 12/17	700 MHz Band 13	800 MHz Band 5	2100 MHz Band 4	1900 MHz Band 2/25
	15.1	15.1	15.3	15.2	15.2

Package Dimensions

19 L x 13 W x 13 H



FRONT

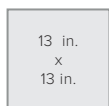

SIDE



TOP/BOTTOM



WEIGHT

MASTER CARTON: 19 L x 13 W x 13 H | 22 Lbs. | Qty 1

FOR PARTNER'S USE

Support



3-Year Warranty from Purchase.

Website: <http://support.weboost.com>

Phone: +1 866 294 1660
Monday to Saturday

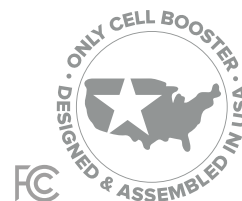

UPC



472047 • 471047_Office 200_SS_032822

Office 100

SKU: 50 Ohm: 472060 **MAP:** \$1,299.99
 75 Ohm: 473060

FEATURES

- Ideal amplifier system for small businesses and warehouses
- Covers 8,000 to 25,000 square feet
- Includes LED indicators
- Is FCC approved and works on all U.S. carrier networks, including Verizon, AT&T, T-Mobile, UScellular, and more

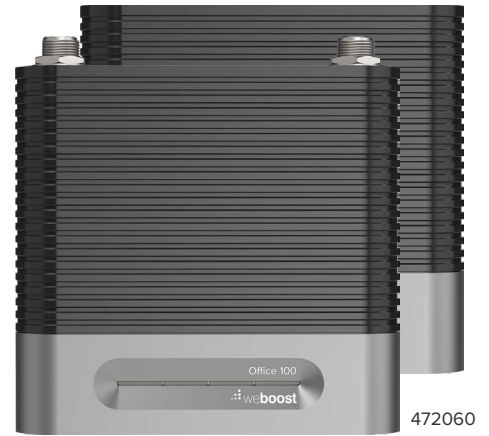

Kit Includes

472060 50 Ohm Kit	Office 100 Amplifier	Omni Plus Antenna 314422	Inside Dome Antenna 304412	Lightning Surge Protector 859902	2ft Low-Loss Wilson400 Cable 952302	60ft Low-Loss Wilson400 Cable 952360	75ft Low-Loss Wilson400 Cable 952375
473060 75 Ohm Kit	Office 100 Amplifier	Omni Plus Antenna 314423	Inside Dome Antenna 304419	Lightning Surge Protector 859992	2ft Low-Loss RG11 Cable 951127	60ft Low-Loss RG11 Cable 951160	75ft Low-Loss RG11 Cable 951175

About

weBoost **Office 100** is an ideal amplifier solution for small businesses and warehouses up to 25,000 sq. ft. With Office 100, anyone who walks into the business will enjoy fewer dropped calls, uninterrupted texts, better voice quality, improved hotspot capability, faster internet speeds, better streaming, and more. All components needed for do-it-yourself installation are included. Office 100 is 5G compatible and improves cell signal on all U.S. carrier networks, including Verizon, AT&T, T-Mobile, UScellular, and more. Office 100 comes with an industry-leading 3-year manufacturer's warranty and a 30-day money-back guarantee.

Specifications

SKU NUMBER	472060* / 473060*
FREQUENCIES	Band 12/17 700 MHz Band 13 700 MHz Band 5 850 MHz Band 4 1700/2100 MHz Band 25/2 1900 MHz
MAX GAIN	72 dB
MAX UPLINK POWER	24 dBm
MAX DOWNLINK POWER	12 dBm
IMPEDANCE	50 Ohm / 75 Ohm
POWER	110-240V AC, 50-60 Hz, 20 W
CONNECTORS	N-Female / F-Female
BOOSTER DIMENSIONS	6 x 6 x 1.8 in
BOOSTER WEIGHT	1.9 lbs

† ⚠️ WARNING: This product can expose you to chemicals including Nickel, which is known to the State of California to cause cancer, and Bisphenol A, which is known to the State of California to cause birth defects or other reproductive harm. For more information go to www.P65Warnings.ca.gov

How It Works

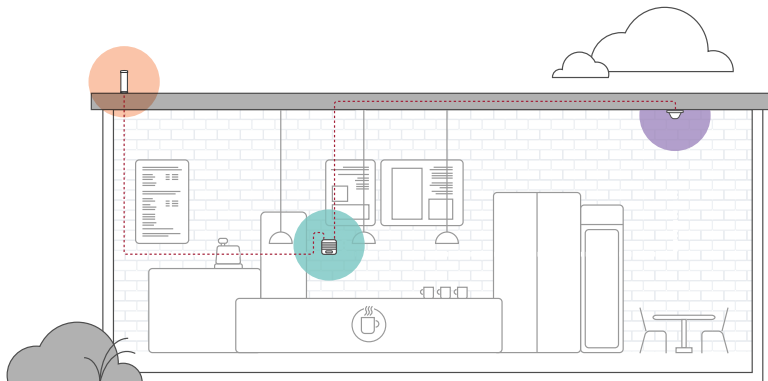

- 1 Outside antenna:** The outside antenna communicates back and forth with nearby cell towers.
- 2 Booster:** The booster amplifies any cell signals it receives from the outside antenna.
- 3 Inside antenna:** The inside antenna broadcasts these signals for use throughout your business.

473060

Package Dimensions

13 L x 13 W x 15 H

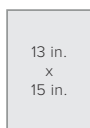

FRONT

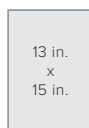

SIDE



TOP/BOTTOM



WEIGHT

MASTER CARTON: 13 L x 13 W x 15 H | 16 Lbs. | Qty 1

FOR PARTNER'S USE

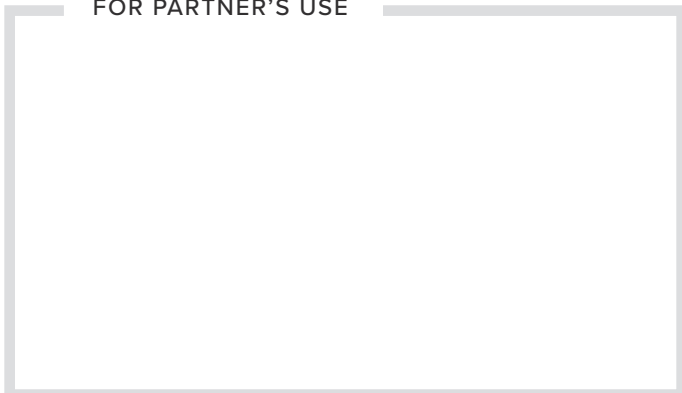

472060 • 473060_Office100_SS_062321

Support



3-Year Warranty from Purchase.

Website: <http://support.weboost.com>

Phone: +1 866 294 1660
Monday to Saturday

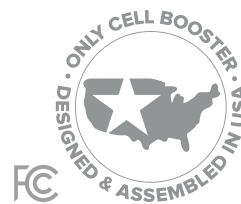

UPC



Drive Reach Fleet

SKU: 470254 MAP: \$524.99

FEATURES

- Enhances all available wireless network signals and speeds throughout a fleet vehicle (Police, Work, Service and Delivery vehicles).
- Boosts signal strength for cellular-based fleet tracking devices allowing fleet managers to better track vehicles, even in weak signal areas.
- Works with ALL cellular devices in the vehicle on ALL carriers simultaneously.
- Increases cellular range, provides fastest available data speeds and improves call quality.
- **REQUIRES PROFESSIONAL INSTALLATION.**



- BOOSTS SIGNAL ON ALL AVAILABLE NETWORK SPEEDS
- FAST NETWORK SPEEDS
- UP TO +50 dB GAIN
- MULTI-USER WIRELESS BOOSTER
- REQUIRES PROFESSIONAL INSTALLATION

⚠️ WARNING: This product can expose you to chemicals including Nickel, which is known to the State of California to cause cancer, and Bisphenol A, which is known to the State of California to cause birth defects or other reproductive harm. For more information go to www.P65Warnings.ca.gov

Kit Includes



Drive Reach



NMO Antenna (314405)



Slim Low-Profile Antenna (314401)



Hardwire Power Supply (950079)



3/4 inch NMO Mount w/ 14 ft. cable (901150)

6 ft. RG58 extension cable

Hole drilling protective tape

O-ring sealant

About

The **Drive Reach Fleet** is weBoost's most powerful, in-vehicle cell signal booster yet. Designed for use in law enforcement, government, or commercial fleet vehicles, Drive Reach Fleet delivers a game-changing level of uplink output power—up to 29.5 dBm.

With this 5 dB increase in signal output, Drive Reach Fleet effortlessly provides your team with the enhanced signal strength needed to communicate and stay connected when it matters most. The Drive Reach Fleet boosts voice and data signal for multiple users and cellular-connected devices simultaneously within the fleet vehicle. This kit uses a high-performance NMO antenna, which **REQUIRES PROFESSIONAL INSTALLATION**. The Drive Reach Fleet enhances all available wireless network signals and speeds with 50 dB system gain—the maximum allowed by the FCC. Drive Reach Fleet is compatible with all U.S. mobile carriers including Verizon, AT&T, T-Mobile, US Cellular, Straight Talk and more. Like all weBoost products, the Drive Reach Fleet features a 2-year warranty along with a 30-day money back guarantee.

Specifications

MODEL NUMBER	470254 [†]	
FREQUENCIES	Band 12/17	700 MHz
	Band 13	700 MHz
	Band 5	850 MHz
	Band 4	1700/2100 MHz
	Band 25*/2	1900 MHz
MAX GAIN	50 dB	
IMPEDANCE	50 Ohm	
POWER	12V 1.8A	
CONNECTORS	SMA Female	
BOOSTER DIMENSIONS	6 x 4.5 x 1.5 in.	
BOOSTER WEIGHT	1.80 lbs.	

[†]New frequency band utilized by Drive Reach.

Installation

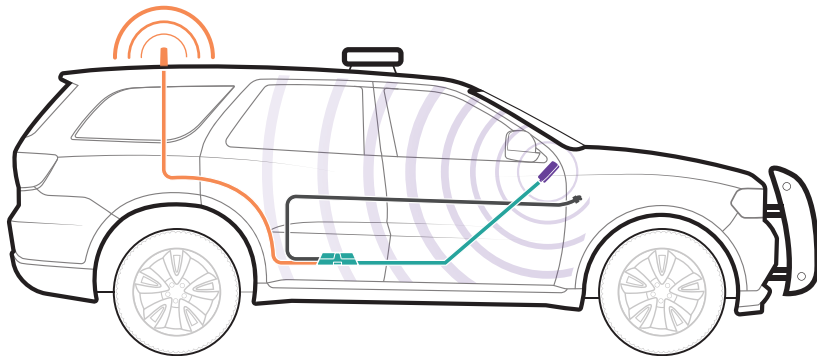

- 1 Receives signal:** The powerful antenna reaches out to access voice and data signals, and deliver them to the booster.
- 2 Boost signal:** The booster receives the signal, amplifies it, and serves as a relay between your phone and the nearest cell tower.
- 3 Broadcasts signal:** Your devices get a stronger signal, and calls and data are fed through the booster back to the network.

Available Accessories

Drive Reach
Soft Install Kit
318406*

Package Dimensions

10.25 L x 10.25 W x 3.5 H

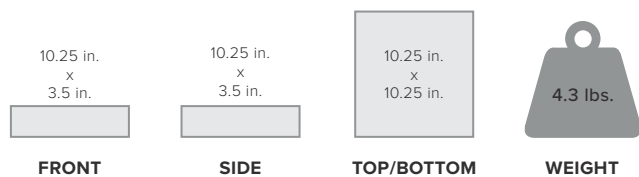

MASTER CARTON: 22 L x 18 W x 12.5 H | 45.4 lbs. | QTY 10

FOR PARTNER'S USE

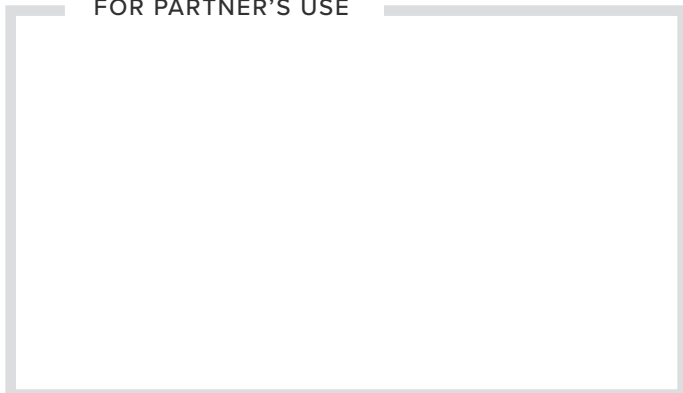

470254_DriveReachFleet_SS_082522

Support



2-Year Warranty from Purchase.

Website: <http://support.weboost.com>

Phone: +1 866 294 1660
Monday to Saturday

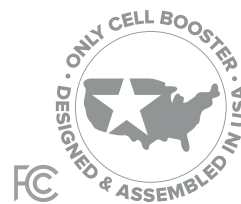

UPC



Drive X Fleet

SKU: 473021 MAP: \$479.99

FEATURES

- Enhances all available network speeds for multiple cellular devices and users simultaneously within a fleet vehicle.
- Boosts signal strength for cellular-based fleet tracking devices allowing fleet managers to better track vehicles, even in weak signal areas.
- Works with ALL cellular devices in the vehicle on ALL carriers simultaneously.
- Increases cellular range, provides fastest available data speeds, and improves call quality.
- **REQUIRES PROFESSIONAL INSTALLATION.**



⚠️ WARNING: This product can expose you to chemicals including Nickel, which is known to the State of California to cause cancer, and Bisphenol A, which is known to the State of California to cause birth defects or other reproductive harm. For more information go to www.P65Warnings.ca.gov

Kit Includes



Drive X



NMO Antenna (314405)



Slim Low-Profile Antenna (314401)



12V Hardwire Power Supply (851111)



3/4 inch NMO Mount w/ 14 ft. cable (901150)

6 ft. RG58 extension cable

Hole drilling protective tape

O-ring sealant

About

The **Drive X Fleet** is a powerful cellular signal booster, specifically designed for fleet vehicles like police cars, government or commercial vehicles, delivery trucks, or whatever your fleet might look like. It boosts all carriers simultaneously, giving your staff the signal strength they need to communicate and stay connected with others on your team regardless of the carrier they use.

This kit uses a high performance NMO antenna, which **REQUIRES PROFESSIONAL INSTALLATION.** The Drive X Fleet boosts voice and data with max FCC-allowed 50 dB system gain, enhancing all available network speeds and cellular bands for improved coverage.

Compatible with all U.S. wireless carriers including Verizon, AT&T, T-Mobile, USCellular, Straight Talk and more.

Like all weBoost products, the Drive X Fleet comes with a 2-year warranty and 30-day money back guarantee.

Specifications

MODEL NUMBER	473021†	
FREQUENCIES	Band 12/17	700 MHz
	Band 13	700 MHz
	Band 5	850 MHz
	Band 4	1700/2100 MHz
	Band 2	1900 MHz
MAX GAIN	50 dB	
IMPEDANCE	50 Ohm	
POWER	6V / 2.5A	
CONNECTORS	SMA Female	
BOOSTER DIMENSIONS	6.25 x 4.5 x 1 in	
BOOSTER WEIGHT	.77 lbs	

Installation

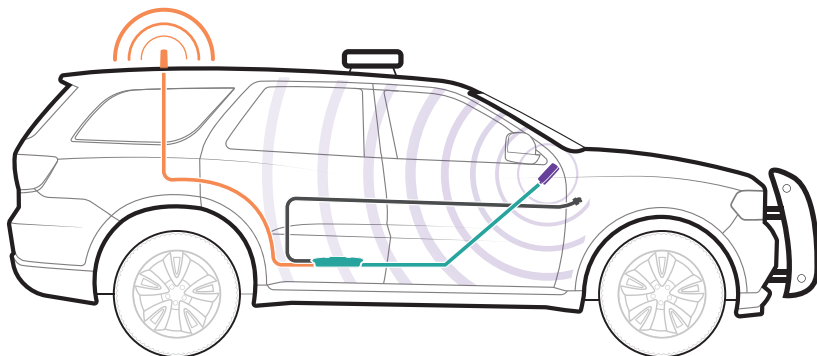

- 1 Receives signal:** The powerful antenna reaches out to access voice and data signals and deliver them to the booster.
- 2 Boost signal:** The booster receives the signal, amplifies it, and serves as a relay between your phone and the nearest cell tower.
- 3 Broadcasts signal:** Your devices get a stronger signal, and calls and data are fed through the booster back to the network.

Available Accessories



Magnetic NMO Mount
900037*



Soft Install Kit
318405*

Package Dimensions

11 L x 11 W x 4 H

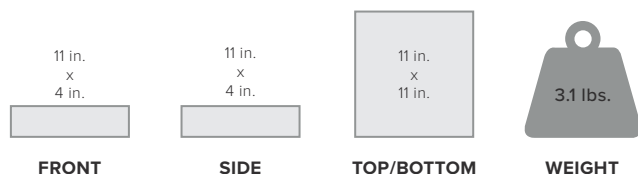

MASTER CARTON: 36 L x 17 W x 13 H | 42 lbs. | QTY 13

Support



2-Year Warranty from Purchase.

Website: <http://support.weboost.com>

Phone: +1 866 294 1660
Monday to Saturday

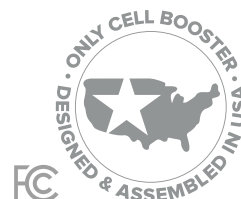

FOR PARTNER'S USE

UPC

Drive X FLEET



8 10005 96155 4

473021_DriveXFleet_SS_072222

Drive Reach OTR Fleet

SKU: 471254 **MAP:** \$549.99

FEATURES

- Enhances all available wireless network signals and speeds in a passenger vehicle—car, truck, van, or SUV.
- Works on ALL cellular devices with ALL carriers simultaneously.
- Enhances cellular talk, text, and high-speed internet.
- Requires professional installation.

⚠️ WARNING: This product can expose you to chemicals including Nickel, which is known to the State of California to cause cancer, and Bisphenol A, which is known to the State of California to cause birth defects or other reproductive harm. For more information go to www.P65Warnings.ca.gov



- BOOSTS SIGNAL ON ALL AVAILABLE NETWORK SPEEDS
- FAST NETWORK SPEEDS
- UP TO +50 dB GAIN
- MULTI-USER WIRELESS BOOSTER

Kit Includes

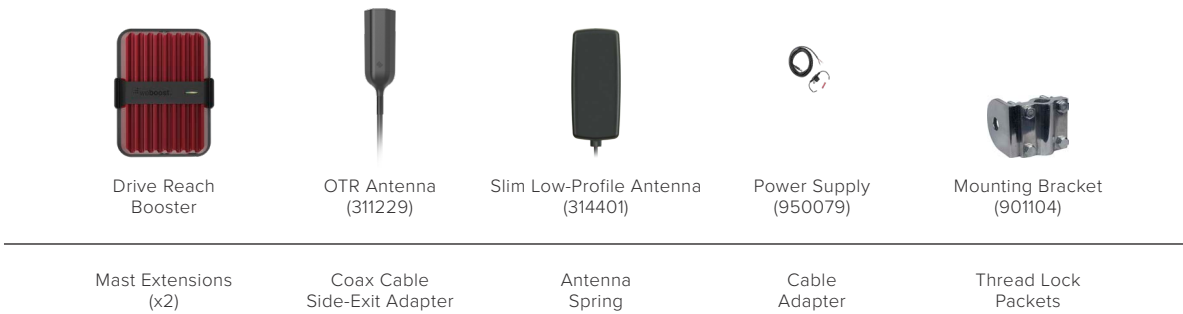

About

The **Drive Reach OTR Fleet** is weBoost's most powerful, in-vehicle fleet truck cell phone signal booster yet. Designed to enhance signal coverage for all fleet vehicles (classes 1-8) with a 3-way antenna mount and mast extensions that go up to 40 inches, the OTR outside antenna is all-terrain, all-weather tough and meets current U.S. Military and NEMA IP66 standards.

The sleek, metallic red exterior of the Drive Reach isn't just for show. The unique fin design increases surface area — ensuring peak performance. It reaches up to 74% farther than our next most powerful vehicle booster to efficiently amplify cell signal. With its enhanced cellular coverage, enjoy fewer dropped calls, better voice quality, faster data speeds, and extended battery life.

Drive Reach simultaneously boosts cell signal for multiple users and devices. Professional installation is required for fleet vehicles to get on the road to better signal.

Drive Reach also has a 2-year manufacturer's warranty and a 30-day money-back guarantee.

Specifications

MODEL NUMBER	471254*	
FREQUENCIES	Band 12/17	700 MHz
	Band 13	700 MHz
	Band 5	850 MHz
	Band 4	1700/2100 MHz
	Band 25*/2	1900 MHz
MAX GAIN	50 dB	
IMPEDANCE	50 Ohm	
POWER	12V 1.8A	
CONNECTORS	SMA Female	
BOOSTER DIMENSIONS	6 x 4.5 x 1.5 in.	
BOOSTER WEIGHT	1.80 lbs.	

*New frequency band utilized by Drive Reach.

How It Works

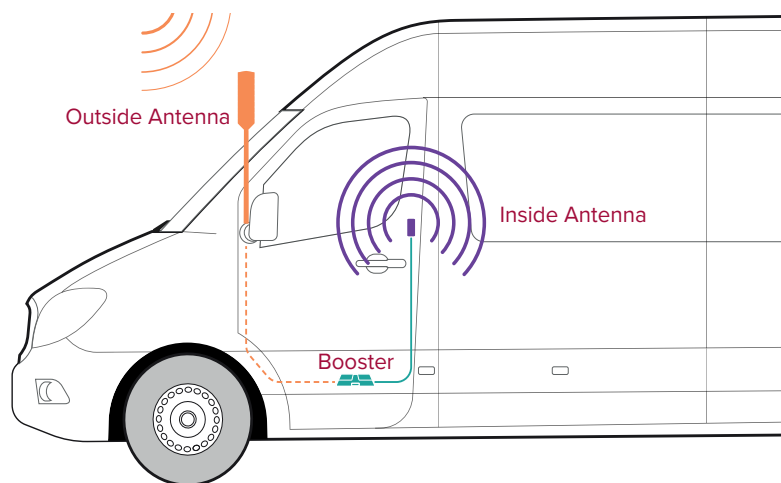

- 1 Receives signal:** The outside antenna picks up cell signal from nearby cell towers.
- 2 Boost signal:** The booster receives the signal from the outside antenna and amplifies it.
- 3 Broadcasts signal:** The inside antenna broadcasts the boosted signal to nearby devices.

Available Accessories



Soft Install Kit
318406*

Package Dimensions

18.38 L x 6.38 W x 6.63 H



FRONT

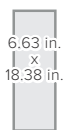

SIDE



TOP/BOTTOM



WEIGHT

MASTER CARTON: 22 L x 18.5 W x 12.5 H | 37.6 lbs. | QTY 6

Support



2-Year Warranty from Purchase.

Website: <http://support.weboost.com>

Phone: +1 866 294 1660
Monday to Saturday

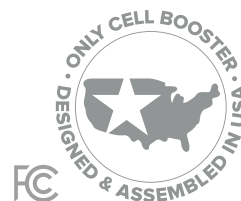

FOR PARTNER'S USE

UPC



471254_DriveReachOTRFleet_SS_122921

Drive Reach Flex Fleet

SKU: 478061 MAP: \$549.99

FEATURES

- Designed for use in any fleet — service vans, emergency vehicles, work trucks, electric vehicles, and more
- Boosts signal strength for cellular-based fleet tracking devices allowing fleet managers to better track vehicles, even in weak signal areas.
- Works with ALL cellular devices in the vehicle on ALL carriers simultaneously.
- Increases cellular range, provides fastest available data speeds, and improves call quality.

† **WARNING:** This product can expose you to chemicals including Nickel, which is known to the State of California to cause cancer, and Bisphenol A, which is known to the State of California to cause birth defects or other reproductive harm. For more information go to www.P65Warnings.ca.gov



Kit Includes



About

weBoost's most powerful, 5G-compatible, in-vehicle cell signal amplifier kit is now available with more flexible installation options. The **Drive Reach Flex Fleet** is designed for use in any fleet vehicle — service vans, work trucks, electrical vehicles, and more. Using high-performance NMO antenna with magnetic mount and providing two power supply options, this kit can be professionally installed without permanently altering a vehicle. With up to 50 dB max gain, Drive Reach Flex instantly provides your team with improved cell signal for seamless tracking, reliable communication, and faster data speeds on any network and any cellular-connected device.

Specifications

MODEL NUMBER	478061†	
FREQUENCIES	Band 12/17	700 MHz
	Band 13	700 MHz
	Band 5	850 MHz
	Band 4	1700/2100 MHz
	Band 25/2	1900 MHz
MAX GAIN	50 dB	
IMPEDANCE	50 Ohm	
POWER	12V 1.8A	
CONNECTORS	SMA	
BOOSTER DIMENSIONS	6 x 4.5 x 1.5 in.	
BOOSTER WEIGHT	1.80 lbs.	

Installation

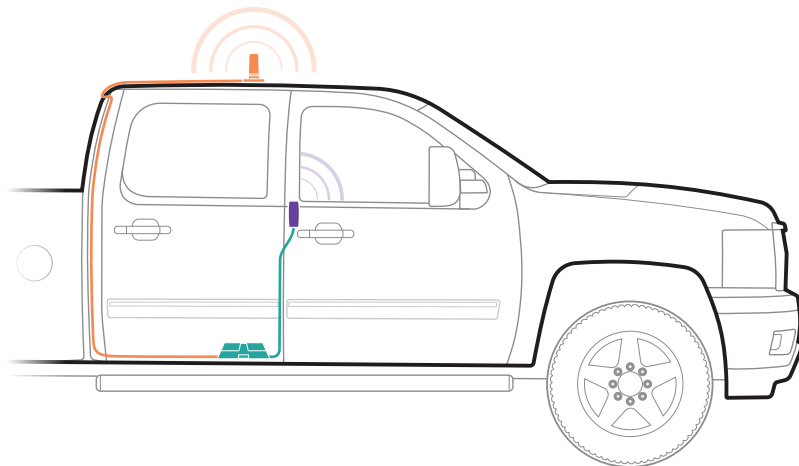

- 1 **Receives signal:** Outside antenna pulls in existing cell signal.
- 2 **Boost signal:** The amplifier boosts the outside cell signal.
- 3 **Broadcasts signal:** The inside antenna broadcasts the improved cell signal to all cellular devices in the vehicle.

Package Dimensions

10.25 L x 10.25 W x 3.25 H



MASTER CARTON: 22.5 L x 19 W x 13 H | 52.785 lbs. | QTY 10

FOR PARTNER'S USE

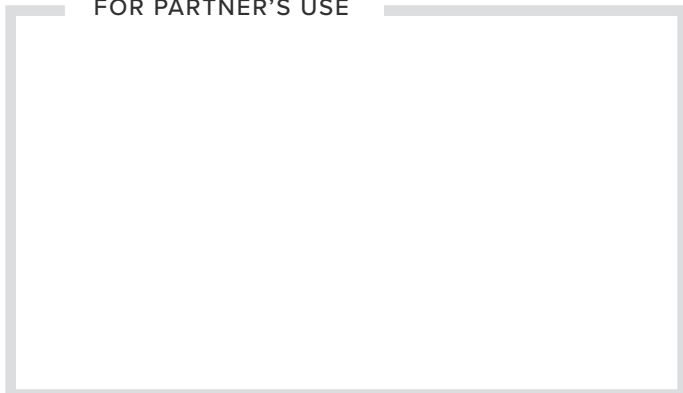

478061_DriveReachFlexFleet_SS_021722

Support

 30-day Money-back Guarantee

 3-Year Manufacturer's Warranty

Website: <http://support.weboost.com>

Phone: +1 866 294 1660
Monday to Saturday

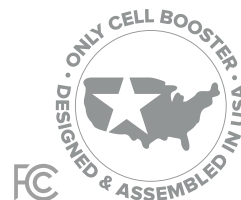

UPC



Antennas (In-Depth)

High-Gain Mobile Antennas

Rugged, High-Gain Antennas Deliver Powerful Performance

Professional drivers demand top performance from their equipment. Wilson provides just that with its line of Trucker, RV, Marine and NMO antennas. Available in three models for alternative installations. These antennas offer the highest allowable gain.

*⚠️ **WARNING:** Cancer and Reproductive Harm - www.P65Warnings.ca.gov.

†⚠️ **WARNING:** This product can expose you to chemicals including Nickel, which is known to the State of California to cause cancer, and Bisphenol A, which is known to the State of California to cause birth defects or other reproductive harm. For more information go to www.P65Warnings.ca.gov



311229*

Drive OTR Antenna

Ruggedized for heavy-duty vehicle, RV and trucking applications. Antenna can be configured into multiple lengths from 7.5-40 in.



311230*

Drive X RV Outside Antenna

High gain, omni-directional, wideband antenna designed for use with RVs and weBoost in-vehicle boosters. Antenna can be configured into multiple lengths from 7.5 - 20.5 in.



304420*

Marine Antenna

9.8-inch High gain, compact, ruggedized for marine applications. Fits standard marine mounts

Features

- Mobile and marine use
- No ground plane required. Built-in ground plane allows for use on any surface - metal, fiberglass, wood, etc.
- Mounting options available for any application

SPECIFICATIONS

PART NUMBER	311229	311230	304420
Impedance	50 ohms		
Signal Pattern	Omni		
Polarization	Vertical		
Ground Plane	Built-In Ground Plane		
Connector	SMA Female	SMA Female	SMA Male
Coax Cable	LMR-195 Black 30 ft / 9.144 m	LMR-195 Black 30 ft / 9.144 m	RG-58 N-male to SMA-male White 20 ft / 6.096 m
Height	7.5 in., 40 in. 190.5 mm., 1016 mm.	7.5 in., 20.5 in. 190.5 mm., 520.7 mm.	9.8 in. / 250 mm.
Mount	Standard CB 3/8-inch x 24 Thread	Fits CB-antenna mounts and RV ladders	Standard Marine Mount 1" x 14 thread

Mobile External Antennas

Stay connected on the road with weBoost mobile antennas

Designed for use with our mobile signal boosters, weBoost wide range of mobile antennas offers top performance and multiple mounting options. Our best-selling magnet-mount antennas install in seconds and are transferable between vehicles. For a more permanent installation, users can choose from glass- or NMO-mount options.

Features

- Perfect for cars, vans and light trucks
- Mobile and indoor use
- Easy to install magnetic mount

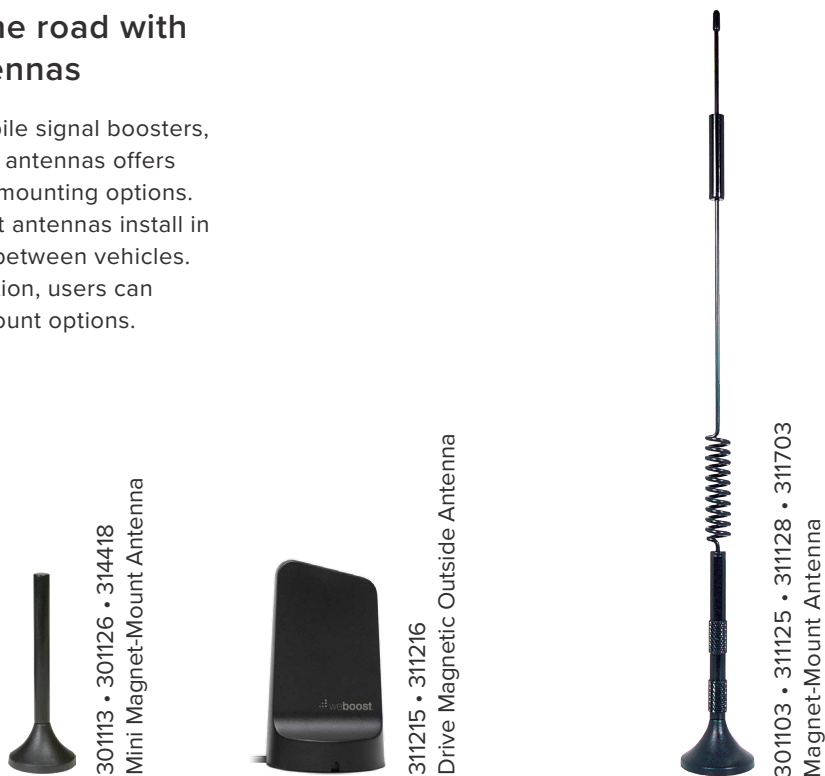

SPECIFICATIONS

	Mini Magnet-Mount Antennas			Magnet-Mount Antennas					
PART NUMBER	301113 [†]	301126*	314418 [†]	311215	311216	301103 [†]	311125*	311128*	311703 [†]
Impedance	50 ohms								
Signal Pattern	Omni								
Polarization	Vertical								
Ground Plane	Metal ground plane required								
Connector	FME Female	SMA Male	SMB Female (plug)	SMB Female (plug)	SMA Male	FME Female	SMA Male	TNC Male	SMA Male
Coax Cable	RG174 - 12.5 ft.	LMR 100 - 10 ft		LMR 100 - 10 ft		RG174 - 12.5 ft.			
Height	4.175 inches / 10.60 cm.			5.25 inches / 13.33 cm.		12.25 inches / 31.12 cm.			
Mount	Rare earth magnet								

*⚠️ **WARNING:** Cancer and Reproductive Harm - www.P65Warnings.ca.gov.

†⚠️ **WARNING:** This product can expose you to chemicals including Nickel, which is known to the State of California to cause cancer, and Bisphenol A, which is known to the State of California to cause birth defects or other reproductive harm. For more information go to www.P65Warnings.ca.gov



314405 NMO Antenna



311104 • NMO Antennas

NMO Antennas		
PART NUMBER	314405 [†]	311104 [†]
Impedance	50 ohms	
Signal Pattern	Omni	
Polarization	Vertical	
Ground Plane	Metal ground plane required	
Connector	NMO	
Coax Cable	RG58U on NMO mount (sold separately)	
Height	3.3 inches / 1.44 cm.	13.88 inches / 35.3 cm.
Mount	NMO mount types	

† ⚠ WARNING: This product can expose you to chemicals including Nickel, which is known to the State of California to cause cancer, and Bisphenol A, which is known to the State of California to cause birth defects or other reproductive harm. For more information go to www.P65Warnings.ca.gov

Low Profile In-Vehicle Antennas

Features

- Low profile antennas for discreet installation
- Includes mounting options
- Designed to work in vehicles



314401/314419
Slim Low-Profile Antenna



301211
Desktop Antenna 50 Ohm

SPECIFICATIONS

PART NUMBER	314401*	314419*	301211*
Impedance	50 ohms		
Signal Pattern	Omni when mounted vertically	Omni when mounted vertically	120° H Plane
Polarization	Vertical		
Connector	SMA Male	SMB	SMA Male
Coax Cable	LMR100 - 10 ft. / 3.05 m.	LMR100 - 10 ft. / 3.05 m.	RG174 - 5 ft. / 1.524 m.
Length	3.2 in. / 8.1 cm.	3.2 in. / 8.1 cm.	5.13 in. / 13 cm.
Width	1.4 in. / 3.6 cm.	1.4 in. / 3.6 cm.	1.56 in. / 4 cm.

*⚠️ **WARNING:** Cancer and Reproductive Harm - www.P65Warnings.ca.gov.

†⚠️ **WARNING:** This product can expose you to chemicals including Nickel, which is known to the State of California to cause cancer, and Bisphenol A, which is known to the State of California to cause birth defects or other reproductive harm. For more information go to www.P65Warnings.ca.gov

High Gain Directional Antennas



311233 50 Ohm
Wide Band
Directional Antenna



314475 75 Ohm
314411 50 Ohm
Wide Band
Directional Antenna



314445 75 Ohm
Wide Band
Directional Antenna

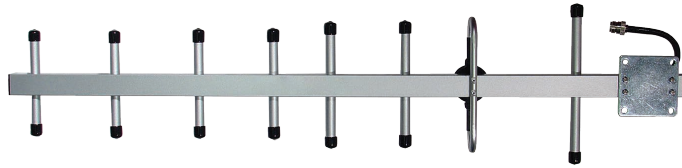

301111 Yagi 800 MHz
Our highest gain antenna for
the 800 MHz band

SPECIFICATIONS

	Yagi		Log-Periodic	
PART NUMBER	301111*	314411*	314475*	314445*
Impedance	50 ohms		75 ohms	75 ohms
Max Power	50 watts			
Polarization	Directional			
	Vertical			
Connector	N-Female		F-Female	F-Female
Material	Aluminum			
Length	32.5 inches / 82.6 centimeters	11.42 inches / 29 centimeters		14.25 inches / 36.2 centimeters
Weight	2.9 ounces / 0.081 kg (with mount)	3.31 lbs. 1.5 Kg		1.37 lbs. .62 Kg
Mount	Mounts on pipe with 0.5 inch to 1.5 inch diameter			Mounts on pipe with 0.5 inch to 3 inch diameter

*⚠️ **WARNING:** Cancer and Reproductive Harm - www.P65Warnings.ca.gov.

Building Antennas

Features

- No ground plane required
- Mounting hardware included
- For fixed installations



Inside Antennas

Outside Antennas

SPECIFICATIONS

	Dome		Panel						Omni				
PART NUMBER	304412*	304419*	311234*	314473*	311135*	311155*	314444*	314440*	304421*	304422*	304423†	304424*	
					314453*								
Impedance	50 ohms	75 ohms	50 ohms	75 ohms	50 ohms	75 ohms	75 ohms	75 ohms	75 ohms	50 ohms	75 ohms	50 ohms	
Polarization	Vertical						Horizontal		Vertical				
Max Power	50 watts		20 watts	50 watts			50 watts		100 watts				
Beamwidth Hor. Plane	360°		~70°/90°		70°/60°			100°	60°/70°		360°		
Beamwidth Ver. Plane	60°		~60°/90°		50°/45°			60°	70°/80°		60°		
VSWR	1.5:1		Low: <2.2:1 High: <1.6:1		1.5:1			< 1.5:1	< 1.5:1	< 1.8	< 1.8	< 1.8	< 1.8
Connector	N-Female	F-Female	N-Female	F-Female	N-Female	F-Female	F-Female	F-Female	F-Female	N-Female	F-Female	N-Female	
Dimensions inches/cm.	7.3 x 3.3 / 185 x 85		6.6x6.2x1.8 / 168 x 158 x 47		8.27 x 7.09 x 1.73 / 21 x 18 x 4.39			11.5 x 7.675 x 3.5 / 2.1 x 194.9 x 88.9	8.875 x 7.125 x 2.625 / 22.5 x 18.1 x 6.7	2.6 x 7.5 / 66 x 19	2.5 x 9.8 / 63 x 250	2.5 x 9.8 / 63 x 250	2.6 x 7.50 / 66 x 19
Ground Plane	Not Required												
Front to Back Ratio	N/A						12/15 dB typical	10/15 dB typical	N/A				

* ⚠️ **WARNING:** Cancer and Reproductive Harm - www.P65Warnings.ca.gov.

† ⚠️ **WARNING:** This product can expose you to chemicals including Nickel, which is known to the State of California to cause cancer, and Bisphenol A, which is known to the State of California to cause birth defects or other reproductive harm. For more information go to www.P65Warnings.ca.gov

Vehicle Antennas — Internal



- Slim Low-Profile Antenna**
314401*
- 700-2700 MHz
 - w/ 10ft LMR100 Cable
 - SMA Male Connector



- Slim Low-Profile Antenna**
314419*
- 700-2700 MHz
 - w/ 10ft LMR100 Cable
 - SMB Connector

Vehicle Antennas — External



- Mini Magnet-Mount Antenna**
301126*
- Omni Directional
 - 700-2700 MHz
 - SMA Male Connector



- Mini Magnet Mount Antenna**
301113†
- Omni directional
 - 700-2700 MHz
 - FME Female Connector
 - w/ 12.5 ft. RG174



- Magnet-Mount Antenna**
301103†
- Omni Directional
 - 800/1900MHz
 - w/ 12.5 ft. RG174 Cable
 - FME Female Connector



- Drive OTR Antenna**
311229*
- Spring Mount
 - w/ 30 ft. cable
 - SMA Male connector
 - Includes 3-Way Mount
 - Includes 7.5-40" Mast options



- Drive RV Antenna**
311230*
- Spring Mount
 - w/ 30 ft. cable
 - SMA Male connector
 - Includes Antenna Mount
 - Includes 7.5-20.5" Mast options



- Magnet-Mount Antenna**
311125*
- 800/1900 MHz Omni Directional
 - w/ 12.5 ft. RG174 A/U
 - Cable SMA Male Connector



- Magnet-Mount Antenna**
311128*
- 800/1900 MHz Omni Directional
 - w/ 12.5 ft. RG174 A/U
 - TNC Male Connector



- Magnet Mount Antenna**
311703†
- 900/1800 MHz Omni Directional
 - w/ 12.5 ft. RG-174A/U Cable
 - SMA Male Connector



- Drive Magnetic Outside Antenna**
311215†
- 700-2700 MHz
 - Omni Directional
 - SMB Plug Female Connector



- Drive Magnetic Outside Antenna**
311216†
- 700-2700 MHz
 - Omni Directional
 - SMA Female Connector



- NMO ANTENNA**
314405†
- Omni directional
 - 700-2700 mhz
 - 800/1900 MHz
 - NMO Connector



- Wide Band Omni-Directional Marine Antenna**
304420*
- Designed as a boat exterior antenna
 - Works with 50 Ohm amplifiers and accessories
 - Weather resistant and easy to install
 - w/ 20 ft. RG58 white cable
 - w/ N-male to SMA male connector



- Overland Antenna**
311248*
- Designed as a boat exterior antenna
 - Works with 50 Ohm amplifiers and accessories
 - Weather resistant and easy to install
 - w/ 20 ft. RG58 white cable
 - w/ N-male to SMA male connector

* ⚠️ **WARNING:** Cancer and Reproductive Harm - www.P65Warnings.ca.gov.

† ⚠️ **WARNING:** This product can expose you to chemicals including Nickel, which is known to the State of California to cause cancer, and Bisphenol A, which is known to the State of California to cause birth defects or other reproductive harm. For more information go to www.P65Warnings.ca.gov

Building Antennas — Internal

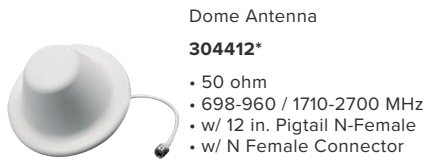

Dome Antenna
304412*

- 50 ohm
- 698-960 / 1710-2700 MHz
- w/ 12 in. Pigtail N-Female
- w/ N Female Connector



Dome Antenna
304419*

- 75 Ohm
- 698-960 / 1710-2700 MHz
- w/ 12 in. Pigtail F Female
- w/ F Female Connector



AG DT Panel Antenna Upgrade
304447*

- 50 Ohm
- 700-2700 MHz 50 Ohm
- Vertically Polarized
- w/20 ft. RG58 Cable
- w/ N Male - SMA Male



Wall Mount Panel Antenna
311135*

- 50 Ohm
- 700-2700 MHz 50 Ohm
- Vertically Polarized
- w/N Female Connector



Wall Mount Panel Antenna
311155*

- 75 Ohm
- 700-2700 MHz 75 Ohm
- Directional
- w/F Female Connector



Desktop Antenna
301211*

- 700-2100 MHz
- w/5 ft. RG174 Cable
- SMA Male Connector



Wall Mount Panel Antenna
314444*

- 75 Ohm
- 700-2700 MHz 75 Ohm
- Horizontal Polarized
- w/F Female Connector



Wall Mount Panel Antenna
314440*

- 75 Ohm
- 700-2700 MHz 75 Ohm
- Horizontal Polarized
- w/F Female Connector



Wall Mount Panel Antenna
311234*

- 50 Ohm
- 617 MHz - 2700 MHz
- Vertically Polarized
- w/N Female Connector

Building Antennas — External

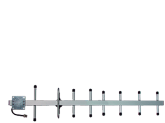

Yagi Antenna
301111*

- 50 Ohm
- 700/800/900 MHz
- Directional
- w/ N Female Connector



Omni-Directional Building Antenna
304421*

- 75 Ohm F-Female Connector
- 698 – 960 / 1710 -2700 MHz



Omni-Directional Building Antenna
304424*

- 50 Ohm N-Female Connector
- 698 – 960 / 1710 -2700 MHz



Omni-Directional Plus Building Antenna
304422*

- 50 Ohm N-Female Connector
- 698 – 960 / 1710 -2700 MHz



Omni-Directional Plus Building Antenna
304423*

- 75 Ohm F-Female Connector
- 698 – 960 / 1710 -2700 MHz



Wide Band Directional Antenna
314411*

- 50 Ohm
- 700 - 2700 MHz
- w/ N Female Connector



Pole Mount Panel Antenna
314453*

- 50 Ohm
- 700 - 2700 MHz 50 Ohm
- Vertically Polarized
- w/ N Female Connector



Pole Mount Panel Antenna
314473*

- 75 Ohm
- 700-2700 MHz 75 Ohm
- Vertically Polarized
- w/ F Female Connector



Wide Band Directional Antenna
314475*

- 75 Ohm
- 700-2700 MHz
- w/ F Female Connector



Wide Band Directional Antenna
314445*

- 75 Ohm
- 700-2700 MHz
- w/ F Female Connector



Wide Band Directional Antenna
311233*

- 50 Ohm
- 617 MHz - 2700 MHz
- w/ N Female Connector

*⚠ **WARNING:** Cancer and Reproductive Harm - www.P65Warnings.ca.gov.

+⚠ **WARNING:** This product can expose you to chemicals including Nickel, which is known to the State of California to cause cancer, and Bisphenol A, which is known to the State of California to cause birth defects or other reproductive harm. For more information go to www.P65Warnings.ca.gov

Accessories

Building Mounts



Two Piece L-Bracket For Use w/Omni-Directional Antenna
901133*



Ceiling Mount for Panel Antenna
901140*

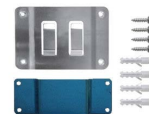

Wall Mount for Panel Antenna
901143*



Antenna Pole Mounting Assembly
901117*

- U-Bracket Assembly
- Wall Mount Bracket
- 10 in. Length x 1.5 in. Diameter Aluminum Tube



Pole Mount for Panel Antenna
901142*

Vehicle Mounts



Marine Antenna Mount
901119*

- Standard 1 inch by 14 thread



3/8x24 3 Way Mount w/ Spade Stud for Cellular Trucker Antenna
901104*



Antenna Mounting Pole (25 ft.)
900203*

- Designed for us with Connect RV 65



3/8x24 Mirror Mount for Mack / Freightliner
901108*



Wall Mount Bracket for Destination RV
990056*



Fleet Soft Install Kit
318405*



Magnetic NMO Mount
900037*

- Works with the NMO 314405



Overland Mounting Bracket & Hardware
901168*



18-inch Mast Extension
991129*

***⚠️ WARNING:** Cancer and Reproductive Harm - www.P65Warnings.ca.gov.

***⚠️ WARNING:** This product can expose you to chemicals including Nickel, which is known to the State of California to cause cancer, and Bisphenol A, which is known to the State of California to cause birth defects or other reproductive harm. For more information go to www.P65Warnings.ca.gov

Cables and Connectors



SMB Plug to SMA Female Adapter
970019*



Connector SMA Male to SMB Adapter
970030*



FME Male - TNC Male Connector
971106*



N Female - FME Female Connector
971107*



N Female - FME Male Connector
971108†



N Female - N Female Barrel Connector
971117*



SMA Male to FME Male Connector
971119*



N Male - F Female Connector
971128*



F Female - F Female Connector for RG6 Cable
971129*



SMA Male to N Male Connector
971132*



FME Female to SMA Female Connector
971136*



N Male - N Male Connector
971148*



F-Male to N-Female Connector
971151*



SMA Male - TNC Female Connector
971153*



N Female - SMA Male Connector
971156*



N Female - SMA Female Connector
971157*



SMA Male to F Female Connector
971165*



N Male Connector (no solder) for 400 cable
970024*



N-Male Crimp Connector for use w/ WILSON400 Cable
971109†



N Male Crimp Connector for RG58 Cable
971116*



F-Male Compression Connector for the RG11 Cable
971150*



F-Male Compression Connectors for the RG11 Cable, Quantity 10 Bagged
971150-10*



N Male Connector (no solder) for 400 cable (qty 10 bagged)
970024-10*



SMA-Male to SMA-Male Connector
971163*

ACTUAL SIZE		LOSS PER 10'	
		800 MHz	1900 MHz
	13/32"	.45 dB	.7 dB
	13/32"	.45 dB	.8 dB
	3/8"	.83 dB	1.35 dB
	3/16"	1.0 dB	2.66 dB
	3/32"	3.58 dB	6.66 dB

⚠ WARNING: Cancer and Reproductive Harm - www.P65Warnings.ca.gov.

⚠ WARNING: This product can expose you to chemicals including Nickel, which is known to the State of California to cause cancer, and Bisphenol A, which is known to the State of California to cause birth defects or other reproductive harm. For more information go to www.P65Warnings.ca.gov

Cables and Connectors



**RG11
COAX CABLE
F-MALE / F-MALE
BLACK**

951127* 2 feet 951100* 100 feet
951150* 50 feet 951155* 500 feet
951175* 75 feet

²compatible with crimp connector 971150. Center pin from connector. Must be soldered onto cable.



**RG6
LOW-LOSS COAX CABLE
F-MALE / F-MALE
WHITE**

950602+ 2 feet
YX030-15W* 15 feet
950620* 20 feet
950630* 30 feet
950650* 50 feet



**WILSON-400
ULTRA LOW-LOSS COAX CABLE³
N-MALE / N-MALE BLACK**

952302* 2 feet 952360* 60 feet
952310* 10 feet 952375* 75 feet
952320* 20 feet 952300* 100 feet
952330* 30 feet 952305* 500 feet
952350* 50 feet 952301* 1000 feet

³equivalent to LMR-400



**RG58 LOW-LOSS FOAM COAX CABLE
SMA-FEMALE / SMA-MALE BLACK**

951147* 10 feet
955815+ 15 feet

N-MALE / SMA-MALE BLACK

955802+ 2 feet
955812+ 10 feet
955822+ 20 feet



**EXTENSION CABLE
SMA-MALE / SMA-FEMALE
955832* 30 feet**



**RG174 EXTENSION CABLE
SMA-MALE / FME-FEMALE BLACK
951144* 6 feet**



**RG58U
LOW-LOSS FOAM COAX CABLE
N-MALE / N-MALE WHITE
951148+ 20 feet**



**FLAT WINDOW CABLE
F-FEMALE / F-FEMALE
WHITE**

951177+ 10 inch



COAX CABLE BLACK

**SMA-MALE TO SMA-MALE
951141+ 6 feet**

**SMA-FEMALE TO SMA-MALE
951130+ 6 feet**

**F-MALE TO SMA MALE CONNECTOR
950631+ 30 feet**

***WARNING:** Cancer and Reproductive Harm - www.P65Warnings.ca.gov.

***WARNING:** This product can expose you to chemicals including Nickel, which is known to the State of California to cause cancer, and Bisphenol A, which is known to the State of California to cause birth defects or other reproductive harm. For more information go to www.P65Warnings.ca.gov

Cables and Connectors



3/4" NMO w/ 14 ft. RG58 Cable and SMA Male Connector
901150*



3/8 in. NMO Mount w/ 14 ft. RG58 Cable w/ SMA Male Connectors
905814*



3/4" NMO w/14 ft. RG58 Cable and SMB Female (Plug) Connector
904423*

Attenuators



6 dB Attenuator, 50 Ohm (N Female Connectors)
859936*



10 dB Attenuator, 50 Ohm (N Female Connectors)
859926*



20 dB Attenuator, 50 Ohm (N Female Connectors)
859927*

Lightning Surge Protector



Lightning Surge Protector w/N-Female Connectors, 50 Ohm
859902†



Lightning Surge Protector w/F-Female Connectors, 75 Ohm
859992†

Taps

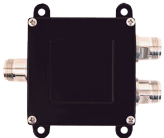

-10 dB Tap 700-2500 MHz w/0.5 dB Pass Thru 50 Ohm (N Female Connector)
859907*

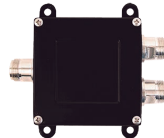

-7 dB Tap 700-2700 MHz w/1.5 dB Pass Thru 50 Ohm (N Female Connector)
859114*



-7 dB Tap 700-2700 MHz w/1.5 dB Pass Thru 75 Ohm (F Connector)
859115*

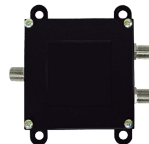

-10 dB Tap 700-2500MHz w/0.5dB Pass Thru 75 Ohm
859976*

* ⚠️ **WARNING:** Cancer and Reproductive Harm - www.P65Warnings.ca.gov.

† ⚠️ **WARNING:** This product can expose you to chemicals including Nickel, which is known to the State of California to cause cancer, and Bisphenol A, which is known to the State of California to cause birth defects or other reproductive harm. For more information go to www.P65Warnings.ca.gov

Splitters

***WARNING:** Cancer and Reproductive Harm - www.P65Warnings.ca.gov.



Splitter 2 way, -3dB, 700-2700 MHz w/ F Female Connectors, 75 Ohm **850034***



Splitter 2 Way -3 dB 700-2800 MHz w/N Female Connectors, 50 Ohm **859957***



Splitter 3 way, -4.8dB, 700-2700 MHz w/ F Female connectors, 75 Ohm **850035***



Splitter 3 Way -4.8 dB 700-2700MHz w/N Female Connectors, 50 Ohm **859980***



Splitter 4 way, -4.8dB, 700-2700 MHz w/ F Female Connectors, 75 Ohm **850036***



Splitter 4 Way -6 dB 700-2700MHz w/N Female Connectors, 50 Ohm **859981***

Combiner/Diplexer • Impedance Converter



Combiner/Diplexer
Dual Band Diplexer/Combiner (50 Ohm, 800-900 MHz/1850-1990 MHz Bands) **859922***

Tools



Compression Tool for RG11 Cable **992201***



Cable Prep Striper Tool for RG11 Cable **992202***



Wilson-400 Cable Prep Striper Tool **992203***





Cable Prep Tool **992208***

***WARNING:** This product can expose you to chemicals including Nickel, which is known to the State of California to cause cancer, and Bisphenol A, which is known to the State of California to cause birth defects or other reproductive harm. For more information go to www.P65Warnings.ca.gov

***WARNING:** Cancer and Reproductive Harm - www.P65Warnings.ca.gov.

Replacement Power Supplies

SKU	IMAGE	NAME	COMPATIBLE WITH WEBOOST	COMPATIBLE WITH WILSONPRO
850011*		AC/DC Power Supply 6V/2.5A	Drive X 475021/655021, Drive X RV 471410/651410, Drive X OTR (Drive 4G-X OTR 470210/650210), Drive X Fleet 473021/653021, Drive X OTR Fleet 474021/564021	
851111*		12V DC Fused Hardwire Power Supply	Drive X 475021/655021, Drive X RV 471410/651410, Drive X OTR (Drive 4G-X OTR 470210/650210), Drive X Fleet 473021/653021, Drive X OTR Fleet 474021/564021, Connect RV 65 471203/471203F	
859913*		DC/DC Vehicle Power Adapter 6V	Drive X 475021/655021, Drive X RV 471410/651410, Drive X OTR (Drive 4G-X OTR 470210/650210), Drive X Fleet 473021/653021, Drive X OTR Fleet,	
850025*		Power Supply	Home Multiroom 470144/650144, Destination RV 850025	
850012*		AC/DC Power Supply 5V/4A	Connect RV 65 471203/471203F, Home Room 472120/652120 5V versions of the following: Drive Reach 470154/ 650154, Drive Reach RV 470354/650354, Drive Reach OTR 472154/652154, Drive Reach Fleet 470254/650254, Drive Reach OTR Fleet 472154/651254	IoT 5 Band 460219/460219F, IoT 5 Band Hardwire Kit 460119/ 460119F
850020*		DC/DC 5V/4A DC Plug	5V versions of the following: Drive Reach 470154/650154, Drive Reach RV 470354/650354, Drive Reach OTR 472154/652154, Drive Reach Fleet 470254/650254, Drive Reach OTR Fleet 472154/651254	
850022*		DC/DC Hardwire Power Supply 5V/4A 12-24VDC	5V versions of the following: Drive Reach 470154/ 650154, Drive Reach RV 470354/650354, Drive Reach OTR 472154/652154, Drive Reach Fleet 470254/650254, Drive Reach OTR Fleet 472154/651254	
850023		AC/DC 12V/3A Power Supply		Pro 710i 460064/650064
850026*		Power Supply	weBoost Installed Home Complete 470145/650145, Home Complete 470145/650145 Office 200 472047/471047/652047/651047 weBoost Installed Office 200 473047	
850030*		Power Supply	Office 100 472060/473060/652060/653060	
850002*		5V / 2.1 A	Drive Sleek 470135/470135F, Drive Sleek OTR 470235/470235F	
859969*		5V AC/DC Building Power Supply		IoT 2 band 460209/460209F
850029*		CLA Power Supply 12V DC/DC	12V versions of the following: Drive Reach 470154/ 650154, Drive Reach RV 470354/650354, Drive Reach OTR 472154/652154, Drive Reach Fleet 470254/650254, Drive Reach Flex Fleet 478061/658061, Drive Reach OTR Fleet 472154/651254	
850015*		Wall Mount Power Supply 12V AC/DC	12V versions of the following: Drive Reach 470154/ 650154, Drive Reach RV 470354/650354, Drive Reach OTR 472154/652154, Drive Reach Fleet 470254/650254, Drive Reach OTR Fleet 472154/651254	
950079*		Hardwire Power Supply 12V DC/DC	12V versions of the following: Drive Reach 470154/ 650154, Drive Reach RV 470354/650354, Drive Reach OTR 472154/652154, Drive Reach Fleet 470254/650254, Drive Reach Flex Fleet 478061/658061, Drive Reach OTR Fleet 472154/651254	

Warranty Overview

2-Year Warranty

weBoost Signal Boosters are warranted for two (2) years against defects in workmanship and/or materials. Warranty cases may be resolved by returning the product directly to the reseller with a dated proof of purchase.

Signal Boosters may also be returned directly to the manufacturer at the consumer's expense, with a dated proof of purchase and a Returned Material Authorization (RMA) number supplied by weBoost. weBoost shall, at its option, either repair or replace the product.

This warranty does not apply to any Signal Boosters determined by weBoost to have been subjected to misuse, abuse, neglect, or mishandling that alters or damages physical or electronic properties.

Replacement products may include refurbished weBoost products that have been recertified to conform with product specifications.

RMA numbers may be obtained by contacting Customer Support.

To start your return:

1. Contact Customer Service at 866-294-1660 for troubleshooting and possible return/exchange of product.
2. After booster information (serial number, model number, date of purchase) is provided, an RMA number is given to the customer.
3. Once shipping information is provided to a Customer Service agent, the agent explains to customer that they can ship the returning product(s) to the following address:

Main Address:
Wilson Electronics
3301 E. Deseret Dr, #18
St George, UT 84790

- This can be shipped in any form/fashion (i.e. UPS, USPS, FedEx, etc.)
4. Once product(s) arrives at our facility, a replacement will be shipped.
 - If refunding product, once we have received package from customer the refund will typically take 7-10 business days for charges to appear in customer's account.

WEBOOST PRODUCT CATALOG

weBoost

3301 E. Deseret Drive
St. George, Utah 84790

1-866-294-1660
1-435-673-5021
Fax: 435-656-2432

support@wilsonelectronics.com

CUSTOMER SUPPORT

1-866-294-1660
support.weboost.com

SALES

1-800-204-4104

INTERNATIONAL SALES

export@weboost.com

 facebook.com/weboost

 linkedin.com/company/wilson-electronics

 instagram.com/weboost/



www.weboost.com